



**NLS-MT37 (Android 8.1)**  
**Portable Data Collector**  
**User Guide**

# Disclaimer

© 2021 Newland Auto-ID Tech. Co., Ltd. All rights reserved.

Please read through the manual carefully before using the product and operate it according to the manual. It is advised that you should keep this manual for future reference.

Do not disassemble the device or remove the seal label from the device, doing so will void the product warranty provided by Newland Auto-ID Tech. Co., Ltd.

All pictures in this manual are for reference only and actual product may differ. Regarding the product modification and update, Newland Auto-ID Tech. Co., Ltd. reserves the right to make changes to any software or hardware to improve reliability, function, or design at any time without notice. The information contained herein is subject to change without prior notice.

The products depicted in this manual may include software copyrighted by Newland Auto-ID Tech. Co., Ltd or third party. The user, corporation or individual, shall not duplicate, in whole or in part, distribute, modify, decompile, disassemble, decode, reverse engineer, rent, transfer or sublicense such software without prior written consent from the copyright holders.

This manual is copyrighted. No part of this publication may be reproduced, distributed, or used in any form without written permission from Newland.

## **Risk Warning Regarding Unauthorized System Updates:**

You should use the Newland-provided tool to update this product's system. Modifying system files through installing a third-party ROM system or using any cracking method may result in product malfunction or data loss and this will void your warranty.

Newland Auto-ID Tech. Co., Ltd. reserves the right to make final interpretation of the statement above.

Newland Auto-ID Tech. Co., Ltd.

No.1, Rujiang West Rd., Mawei, Fuzhou, Fujian, China 350015

<http://www.newlandaidc.com>

## Revision History

Version	Description	Date
V1.0.0	Initial release	2021-3-24
V1.0.1	Update with maintenance chapter	2021-04-08
V1.0.2	Add description about security level of ITF code	2021-05-19
V1.0.3	Add HID output setting description	2021-06-17

# Contents

<b>Chapter 1 About This Guide .....</b>	<b>1</b>
Introduction.....	1
Documentation Set.....	1
Chapter Descriptions .....	1
More Information .....	2
<b>Chapter 2 Getting Started .....</b>	<b>3</b>
Introduction.....	3
Unpacking .....	3
Accessories (Optional) .....	3
Getting Started .....	4
The MT37.....	4
Charging the Battery .....	6
LED.....	7
Keypad.....	8
Communicating with PC.....	9
Installing the SIM Card.....	10
<b>Chapter 3 Basics .....</b>	<b>11</b>
Introduction.....	11
Switching On/Restart/Switching Off the MT37 .....	11
Locking/Unlocking the MT37 .....	12
Home Screen .....	13
Status Icons.....	14
Installing App.....	15
Uninstalling App.....	15
Date & Time.....	16
Display.....	17
Ringtones .....	18
Restoring Factory Settings .....	19

Language & Input Method .....	20
Floating Button Settings .....	21
HID Output Settings .....	22
Shortcuts to Apps .....	27
Widgets .....	27
<b>Chapter 4 Scanning Barcodes .....</b>	<b>28</b>
Introduction.....	28
Scanning 1D/2D Barcode.....	28
Programming Scanner.....	29
Enable scan.....	30
Output Mode.....	31
Scan Mode .....	32
Scan Trigger .....	33
Prefix & Suffix.....	34
Good Read Indicator .....	35
Encoding .....	36
Data Edit.....	37
Broadcast-output settings.....	38
Symbologies.....	39
<b>Chapter 5 Bluetooth .....</b>	<b>43</b>
<b>Chapter 6 Wi-Fi .....</b>	<b>44</b>
Introduction.....	44
Wi-Fi Settings.....	44
IP Settings .....	46
<b>Chapter 7 Mobile Network (Only for 4G Version) .....</b>	<b>47</b>
Introduction.....	47
Mobile Network Settings.....	47
APN Settings .....	48
<b>Chapter 8 Admin Tool.....</b>	<b>49</b>

Introduction.....	49
Admin Mode Setting .....	49
<b>Chapter 9 Whitelist Manager .....</b>	<b>54</b>
Introduction.....	54
Logging in to Whitelist Manager .....	54
<b>Chapter 10 Others .....</b>	<b>55</b>
GPS.....	55
NFC (optional).....	56
Memory Cleanup .....	57
<b>Chapter 11 System Update .....</b>	<b>58</b>
Introduction.....	58
Online Update .....	58
Locate Update .....	58
<b>Chapter 12 App Development Guide.....</b>	<b>61</b>
Development Environment .....	61
Use of Non-standard Interfaces.....	61
<b>Chapter 13 Maintenance &amp; Troubleshooting.....</b>	<b>62</b>
Introduction.....	62
Important Safety & Handling Information.....	62
Disassembly and Retrofit .....	62
External Power Supply.....	62
Abnormal Situation.....	62
Drop Damage.....	62
LCD Screen .....	62
Stacking Heavy Objects .....	62
Mounting Location.....	62
Wireless Functionalities .....	63
Use & Maintenance.....	63

Battery Safety Guidelines.....	63
Troubleshooting.....	64





# Chapter 1 About This Guide

## Introduction

This guide provides instructions for programming and operating the NLS-MT37 portable data collector (hereinafter referred to as “**the MT37**” or “**the terminal**”).

## Documentation Set

The documentation set for the MT37 includes:

- ✧ **NLS-MT37 Portable Data Collector Quick Start:** Describes how to get the NLS-MT37 up and running.
- ✧ **NLS-MT37 Portable Data Collector User Guide:** Describes how to program and use the NLS-MT37.

## Chapter Descriptions

- ✧ *Chapter 1 About This Guide* Provides general description of this manual.
- ✧ *Chapter 2 Getting Started* Provides information on getting the MT37 up and running for the first time.
- ✧ *Chapter 3 Basics* Describes how to program the MT37 for the use of its basic features.
- ✧ *Chapter 4 Scanning Barcodes* Provides the instructions as to how to scan 1D/2D barcodes and how to program the scanner.
- ✧ *Chapter 5 Bluetooth* Explains how to use Bluetooth functionality.
- ✧ *Chapter 6 Wi-Fi* Explains how to use Wi-Fi functionality.
- ✧ *Chapter 7 Mobile Network* Explains how to use Mobile Network functionality.
- ✧ *Chapter 8 Admin Tool* Explains how to use the admin tool.
- ✧ *Chapter 9 Whitelist Manager* Explains how to use the whitelist management tool.
- ✧ *Chapter 10 Others* Explains how to use GPS and NFC functionalities.
- ✧ *Chapter 11 System Update* Explains how to update the system.
- ✧ *Chapter 12 App Development Guide* Describes the app development environment and the use of

non-standard interfaces.

✧ *Chapter 13 Maintenance & Troubleshooting*

Provides troubleshooting solutions for issues that might occur when using the MT37.

## **More Information**

For more product and support information, please visit our web site: <http://www.newlandaidc.com>.

## Chapter 2 Getting Started

### Introduction

This chapter lists the parts and accessories for the MT37 and explains how to install, charge the battery, and power on the MT37 for the first time.

### Unpacking

Carefully remove all protective material from the pack and verify that the followings were received:

- ✧ 1 x NLS-MT37 main unit
- ✧ 1 x USB cable
- ✧ 1 x Wrist lanyard
- ✧ 1 x Quick start manual
- ✧ 1 x Warranty Card

### Accessories (Optional)

- ✧ AC adapter for the MT37

---

# Getting Started

## The MT37

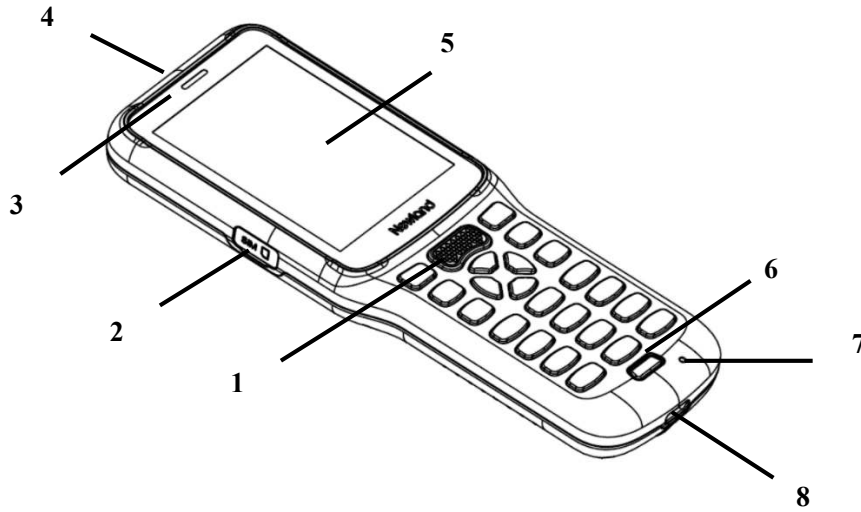

---

1	Scan Key	2	SIM Card Slot (only for 4G version)
3	LED	4	Scan Window
5	Screen	6	Power Key
7	Mic	8	USB Type-C Interface

---

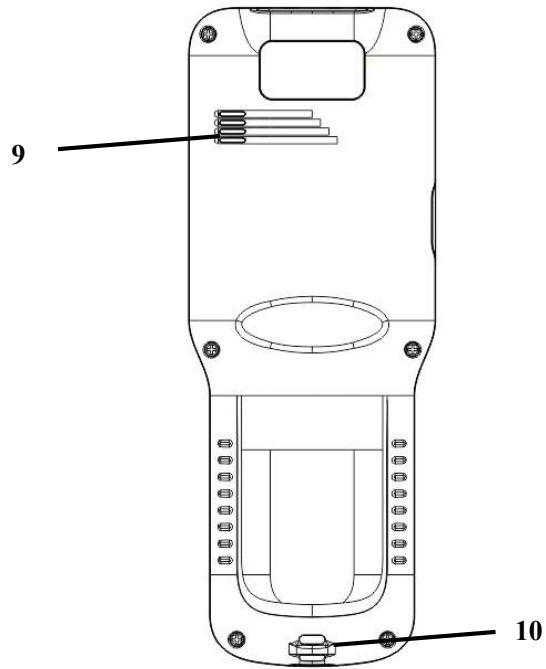

---

**9** Speaker

**10** Rope hole

---

---

## Charging the Battery

There are two methods to charge the battery.

- ✧ **Charge with AC adapter:** It takes less than 3 hours to fully charge it (The terminal is shut down or in sleep mode).

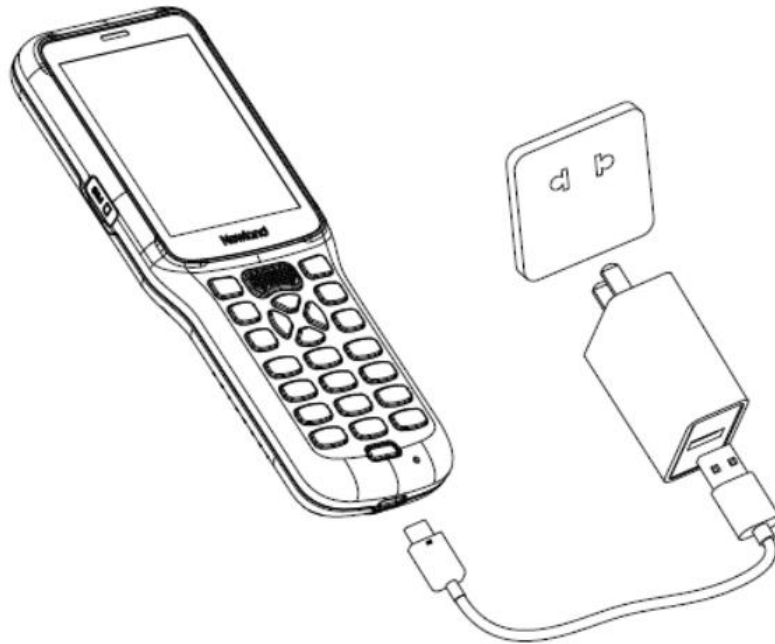

- 1) Low battery may result in malfunction of the terminal. Before using MT37 for the first time, charge the battery for at least 8 hours. Low battery may result in malfunction of the terminal. Before using MT37 for the first time, charge the battery for at least 8 hours.
- 2) Connect the USB connector to a power outlet using the AC adapter & Cable. (Do not plug or pull the USB connector violently to avoid damage)
  - ✧ The AC adapter is recommended to use 5V/2A.

## Charge with PC USB

**Note:** Because the current of USB is only 5V/500mA. It will take a long time to fully charge with a computer.

---

## LED

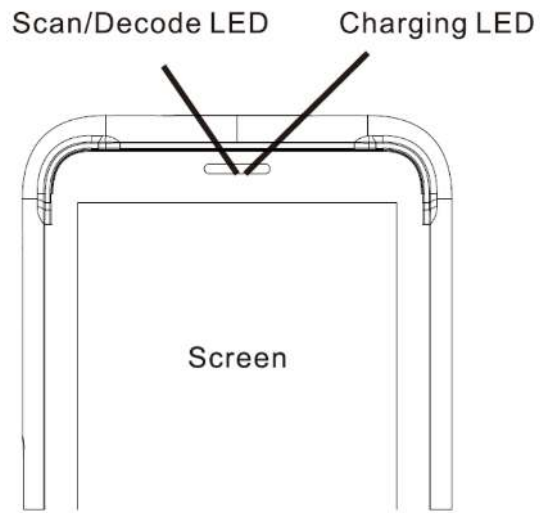

Scan/Decode LED	
Blue LED flashes once	Decode successfully
Charging LED	
Blue LED on	Fully charged
Red LED on	Charging in progress
Red LED flashes	Low-battery alert

**Note:** If MT37 battery is completely drained, please press the power key to turn it on after 15 minutes of being charged.

---

## Keypad

The MT37 has 24 keys including function, alphanumeric, navigation, and scan keys.

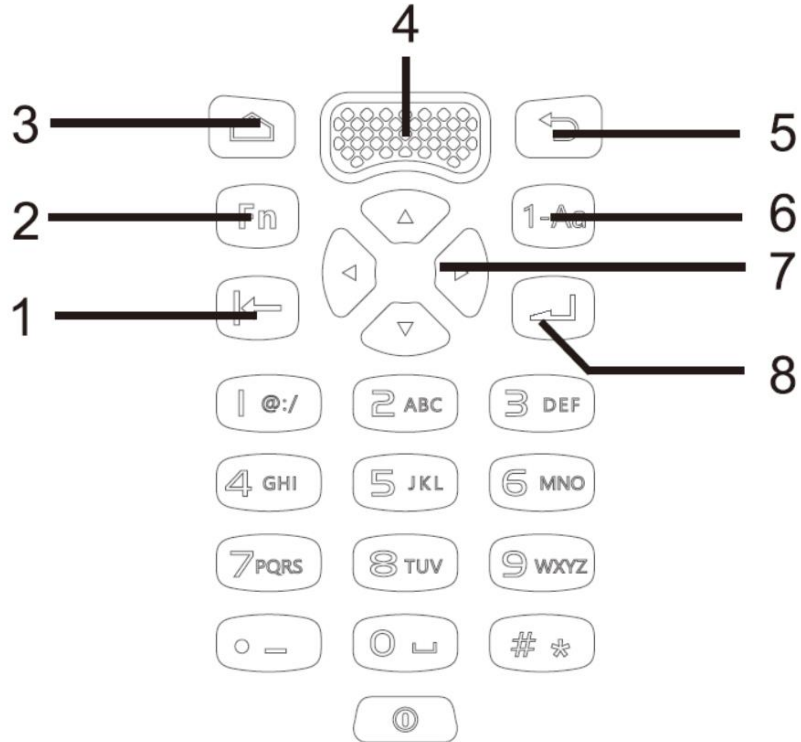

---

1	Backspace Key	2	Fn Key
3	Home Key	4	Scan Key
5	Return Key	6	Alphanumeric Key
7	Navigation Key	8	Enter Key

---

- When Fn Key is pressed, the number key 0-9 will be activated as user-defined key F1-F10.
- Fn+0 refer to F10



---

## Communicating with PC

Step 1: Connect the USB Type-C port on the MT37 to your computer with the included USB cable.

Step 2: Switch the MT37 on. On the Home screen, swipe from top to bottom with one finger in one smooth motion to open the notification bar as shown below.

Step 3: Tap "Tap for more options".

Step 4: Select "Transfer files". Navigate to the "My Computer" section of your computer and look for the newly added drive. Double-click it and you will be connected to the MT37. Then you may handle the files on the terminal through your computer.

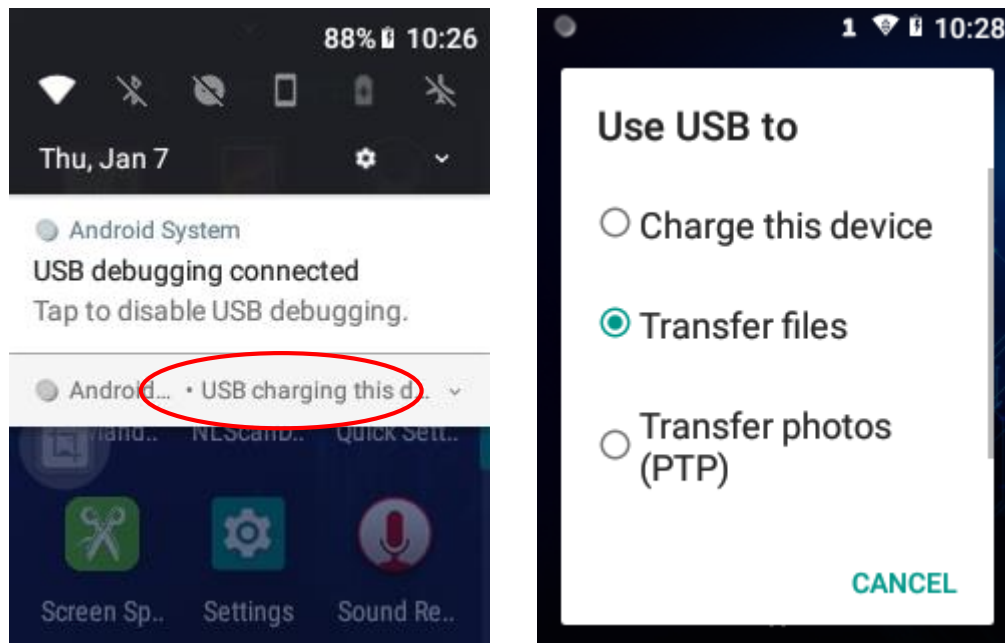

---

## Installing the SIM Card

It should be installed when the device is in power-off state. Otherwise, the SIM card will be damaged.

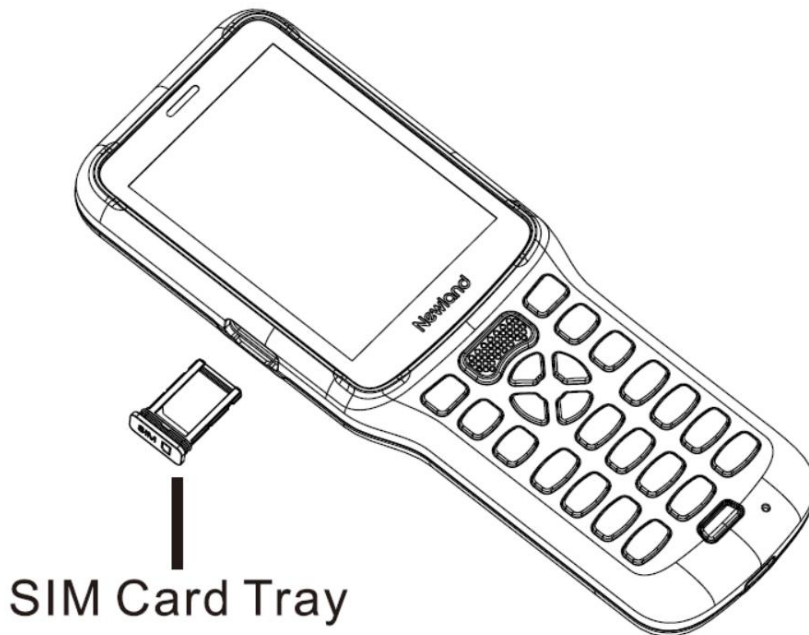

Step 1: Pull the SIM Card tray out from the slot and put the SIM card on it.

Step 3: Then gently push the tray into the slot until it locks in place.

Remark: The SIM card slot is with fool-proof design, please do not insert or pull violently to avoid damage.

## Chapter 3 Basics

### Introduction

This chapter provides the basics of setting and using the MT37.

### Switching On/Restart/Switching Off the MT37

After installing the SIM card and battery and having the MT37 fully charged, you may switch the terminal on.

**Switch the MT37 on:** Hold down the Power key on the bottom of the terminal. Note that the initialization is going to take some time before the MT37 displays the Home screen.

**Restart the MT37:** Hold down the Power key on the bottom of the terminal until the window below pops up, then tap “restart”.

**Switch the MT37 off:** Hold down the Power key on the bottom of the terminal until the window below pops up, then tap “Power off”.

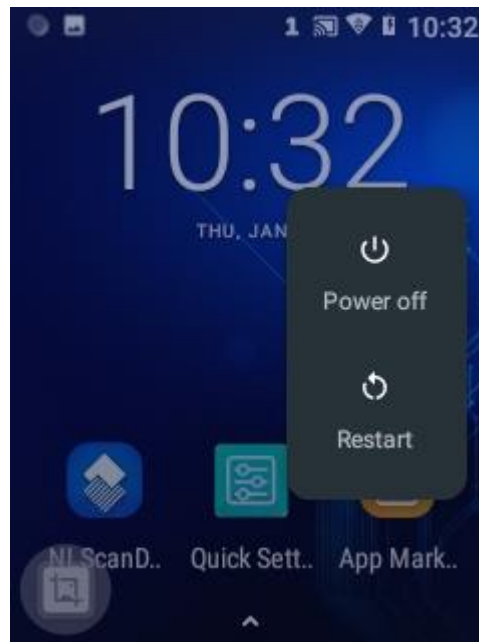

---

## Locking/Unlocking the MT37

**Lock the MT37:** Briefly press the Power key  . If no operation is performed on the MT37 for a preset period of time, the MT37 locks automatically. You can change how long it takes for the MT37 to lock.

**Unlock the MT37:** Briefly press the Power key  , then swipe up from the bottom of screen.

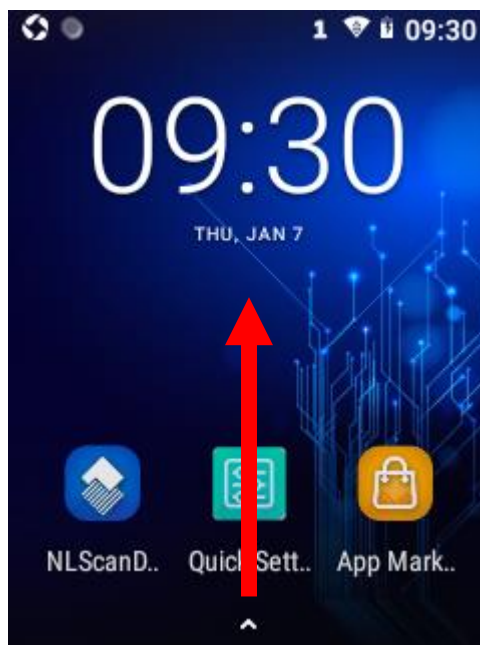

---

## Home Screen

- ✧ **Go to the home screen:** Press the Home key
- ✧ **View another home screen:** Swipe left or right.
- ✧ **Open an app:** Tap it.
- ✧ **View all apps/Open apps list:** Tap 

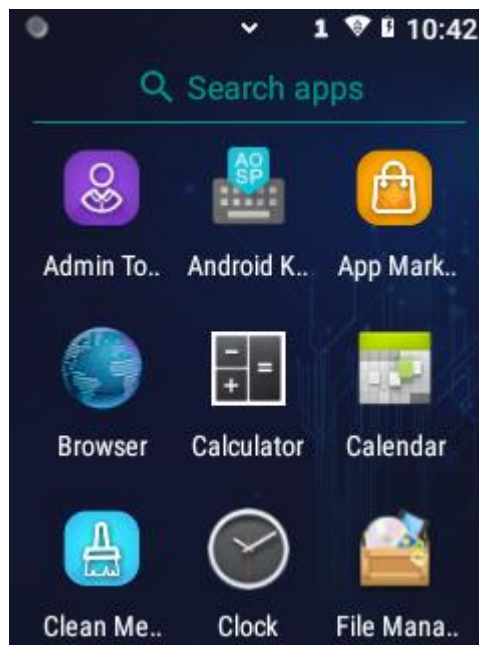











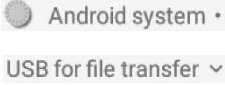

 **Apps List**

- ✧ **Add an app icon to the Home screen:** Tap  on the Home screen. Tap and hold your desired app until it appears on the Home screen and then drags it into a blank area.
- ✧ **Delete an app icon on the Home screen:** Tap and hold your desired app on the Home screen until "X Remove" appears, then drag the app into it. Note that this operation only removes the icon from the Home screen. To remove the app from the MT37, see the **Uninstalling App** section.

## Status Icons

The icons in the status bar at the top of the screen give information about the MT37.

Status Icon	Description	Status Icon	Description
	WLAN		Signal strength
	Bluetooth		Airplane mode
	USB connected		USB debugging
	Missed calls		Battery charging in progress
	Don't disturb mode		Battery fully charged
	Power saving mode		Auto-rotate

---

## Installing App

Use one of the following methods to install a new app on the MT37:

1. Download an APK file from an online app store and install it.
2. Connect the MT37 to PC with the supplied USB cable. Install a new app using the mobile assistant (such as Baidu Mobile Assistant) installed on the PC.

## Uninstalling App

Follow the procedure below to remove an app from the MT37:

Tap  on the Home screen to view all apps. Tap and hold your desired app until "App info" appears, then tap "App info" and uninstall it

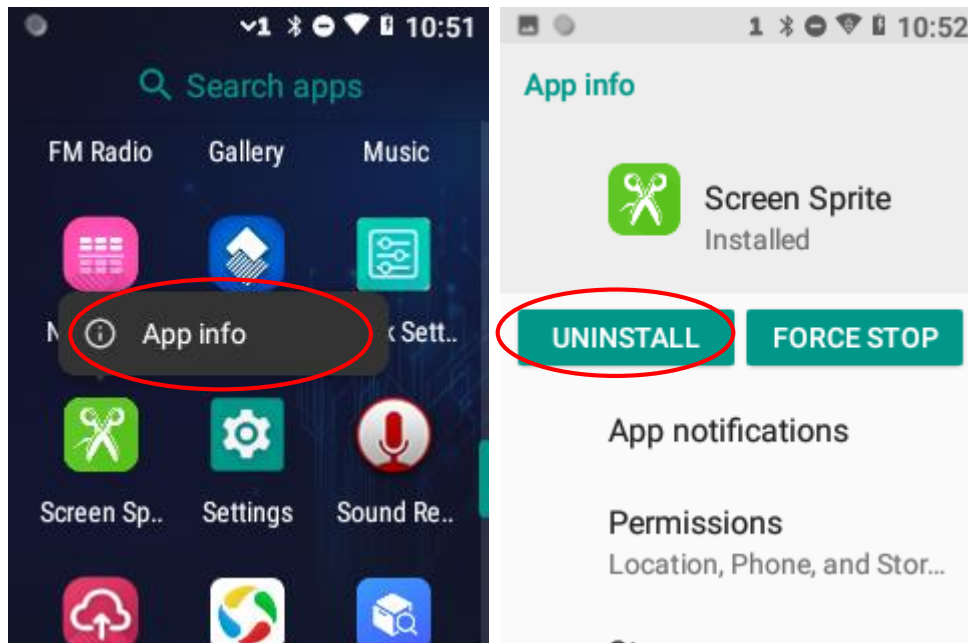

---

## Date & Time



**Set the date and time:** Tap the app icon and then “System” -> “Date & time”, and set the date and time on the screen shown below as per your needs.

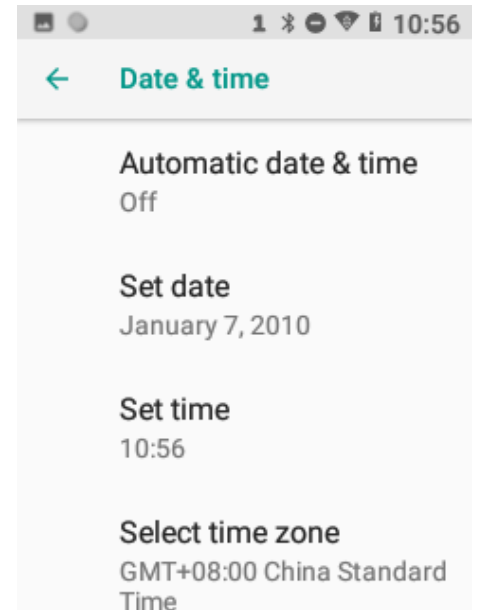
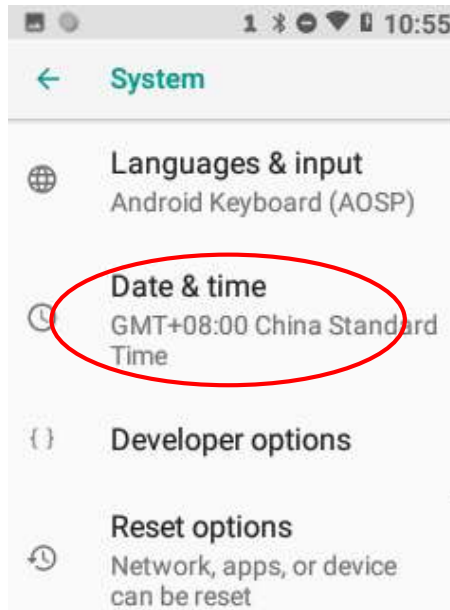
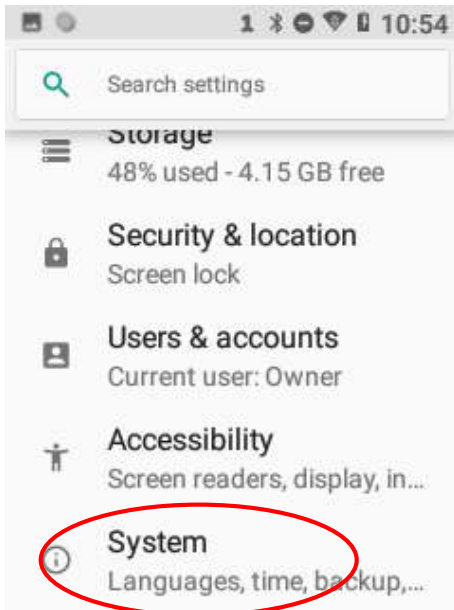



---

## Display

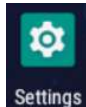

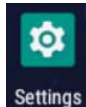
Tap the app icon  and then "Display". Then set the brightness Level, Night Light, wallpaper, sleep timer, font size, and other items on the screen as per your needs.

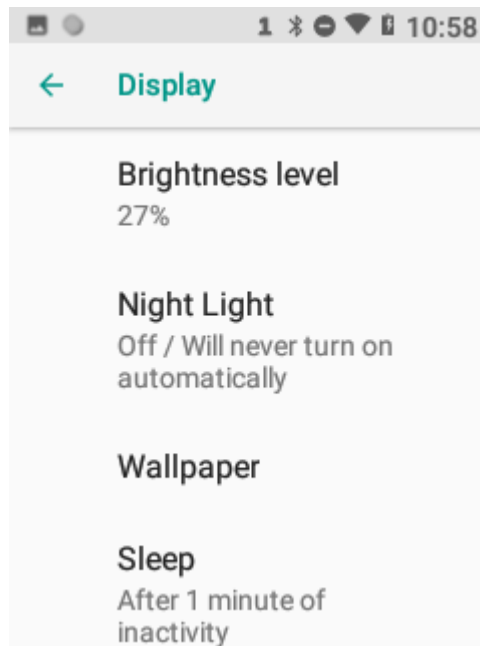
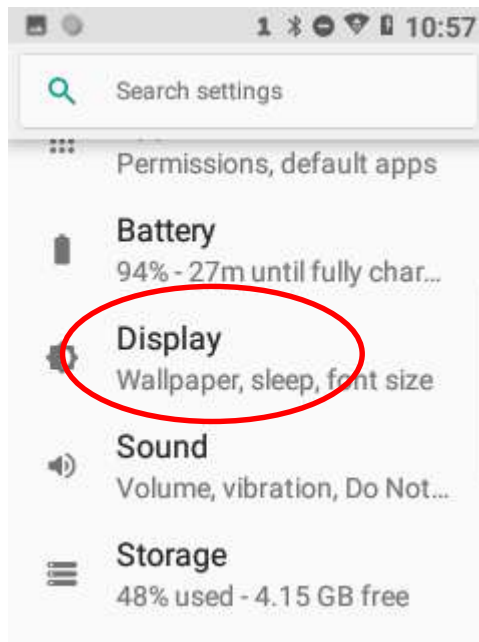

---

## Ringtones

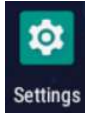

Tap the app icon -> "Sound". Then set the ringtones and other notification sounds as per your needs.

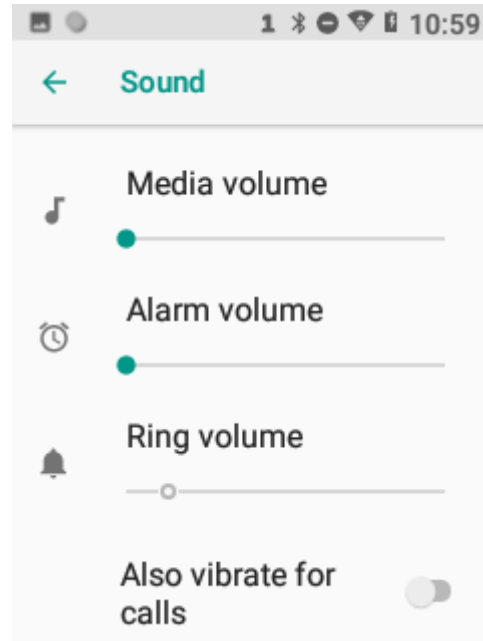
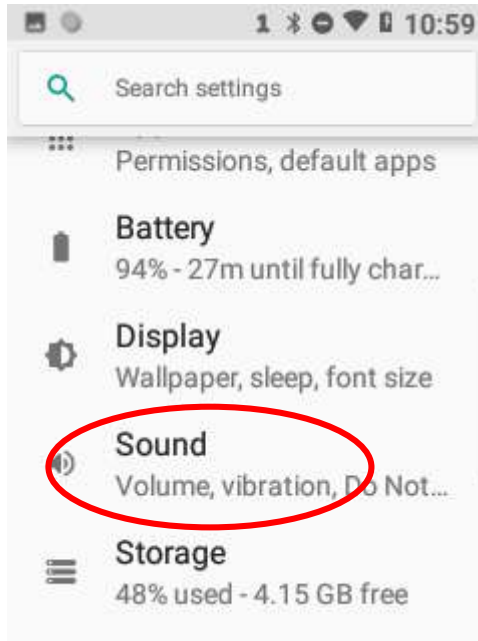

## Restoring Factory Settings

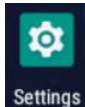

Tap the app icon -> "System" -> "Reset options" -> "Erase all data (factory reset)" -> "RESET PHONE" -> "ERASE EVERYTHING"

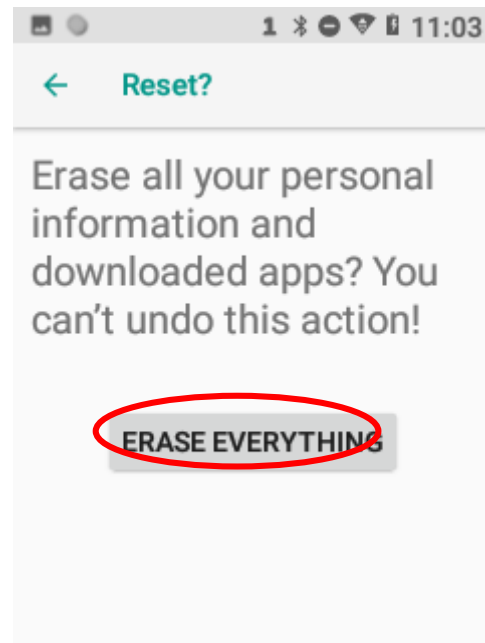
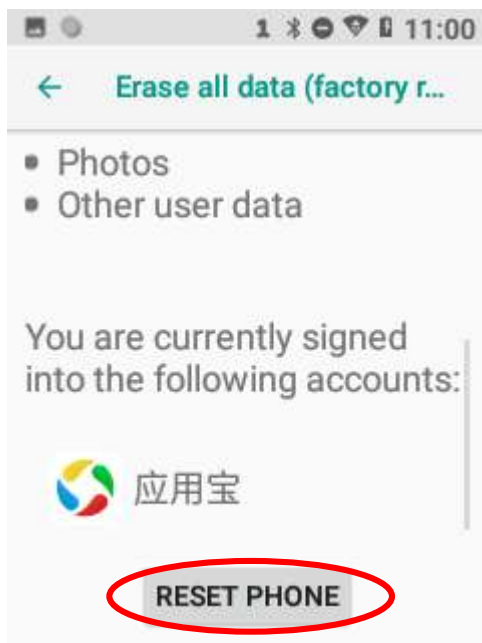
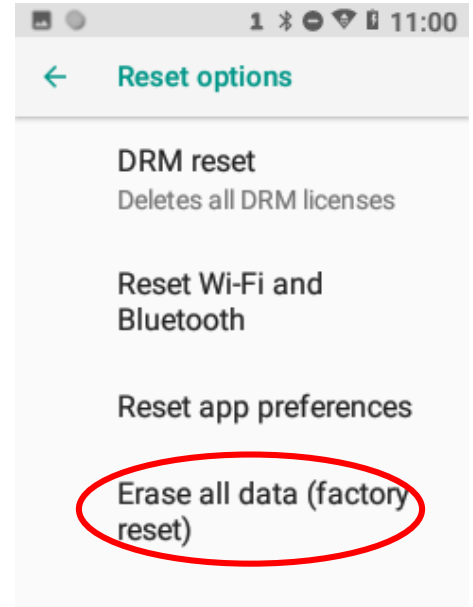
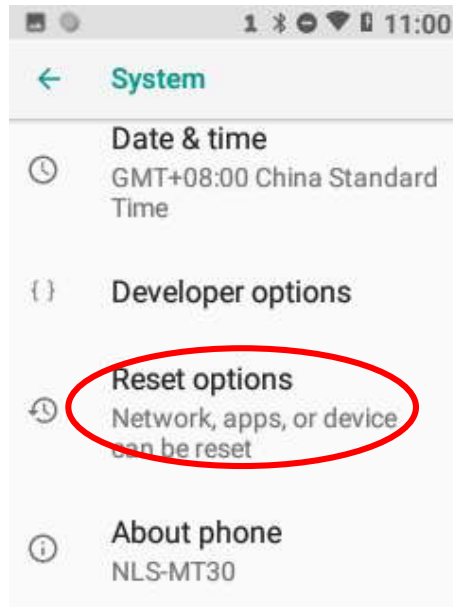
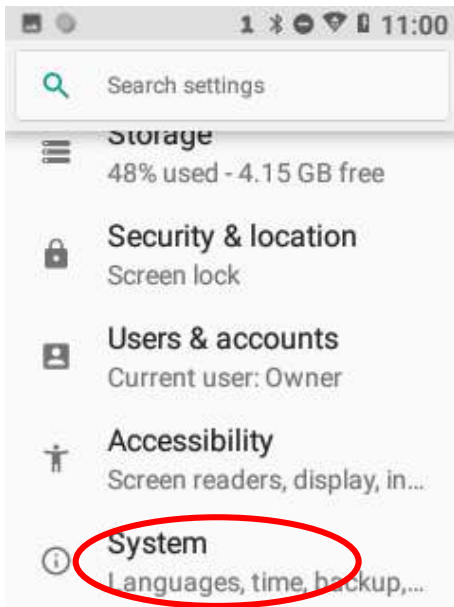

## Language & Input Method

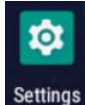

Tap the app icon -> "Languages & input". Then set the language and input method as per your needs.

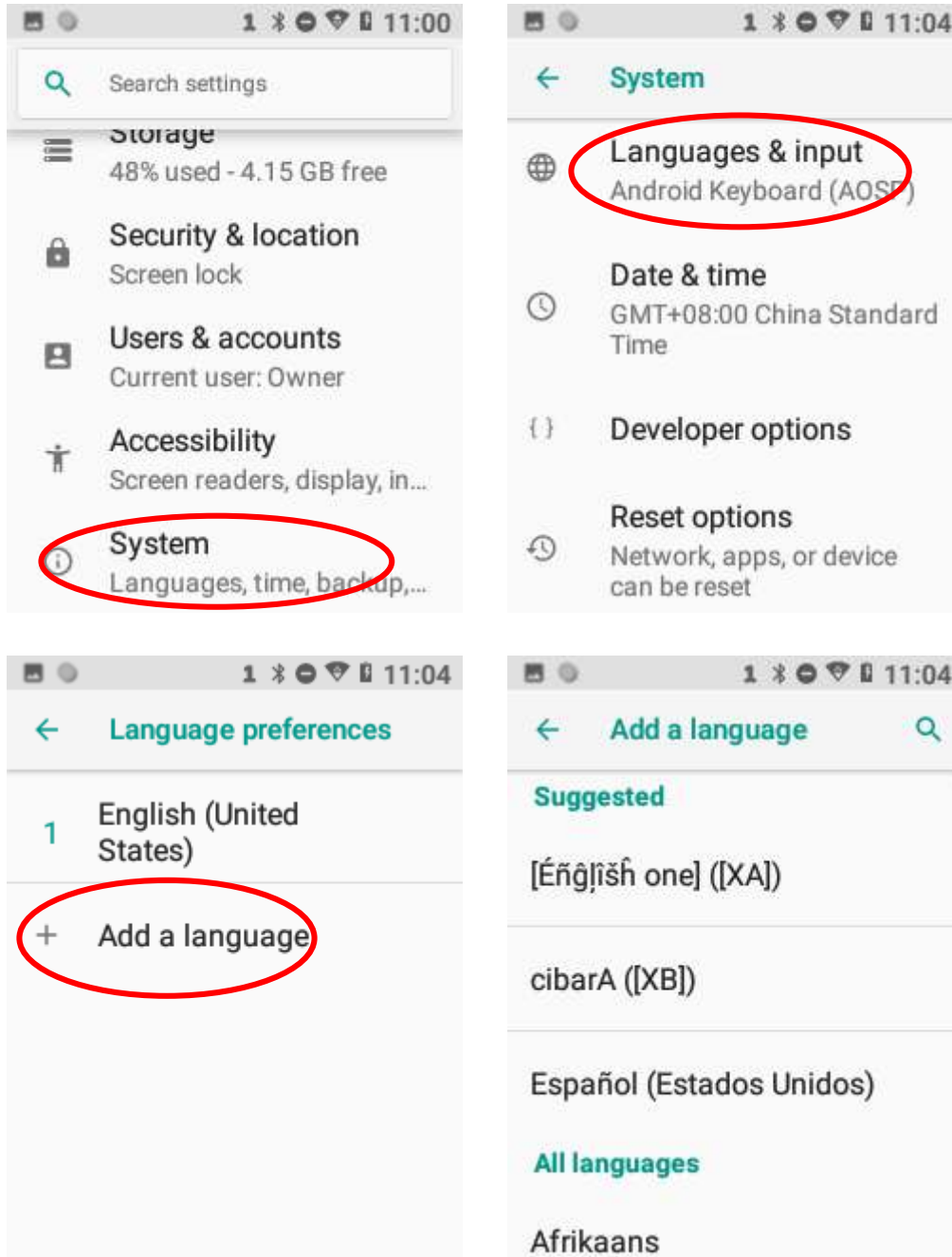

---

## Floating Button Settings

Tapping the floating button can perform tasks such as scanning barcode (**Scan**), taking a screenshot (**Screen snapshot**), turning off screen (**Screen off**), going to the Home screen (**Home**), switching between level and continue scan mode (**Toggle level and continue scan mode**), or showing device name (**Show device name**).

Holding down the floating button  can make it movable.

**Show/Hide the floating button:** Tap the quick setting app icon  -> "Floating Touch"-> select/unselect "Show float box".

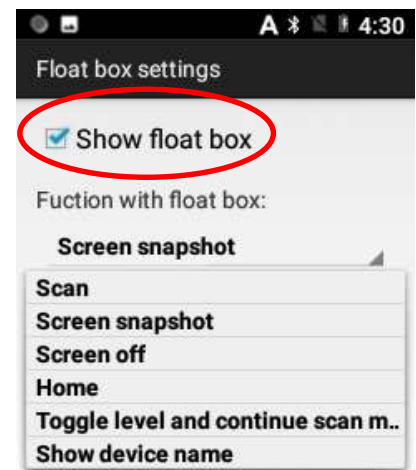
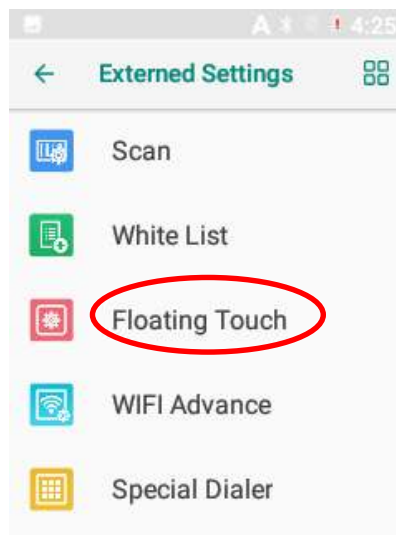

---

## HID Output Settings

The HID output setting function allows users to simulate the MT37 as a wired or wireless scanner. There are two connection methods for this function.

### **\*\*USB HID Output\*\***

1. Use the MT37 device to scan the below QR code, then the output mode of the MT37 will switch to “Output via API”.



2. Tap the quick setting icon  Quick Sett... -> “Output Settings” -> “USB Output Settings” -> Turn on “Set to hid when charging”.

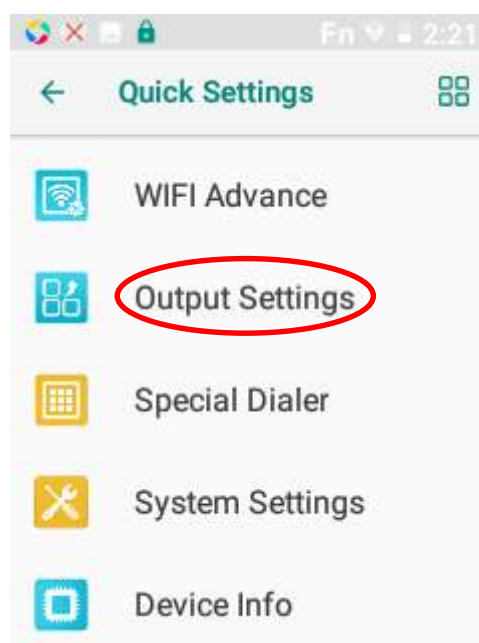

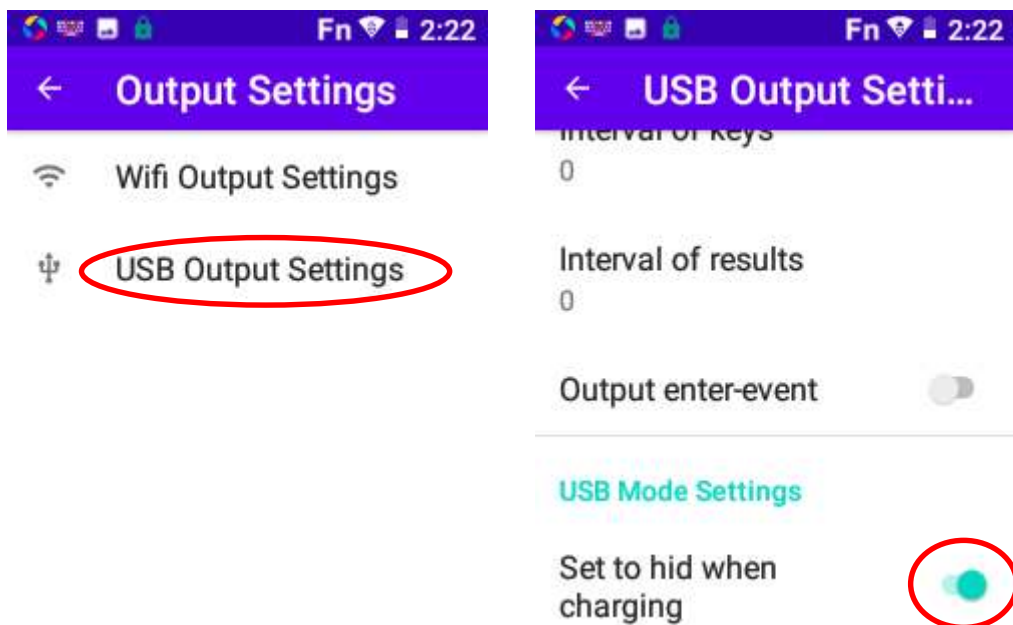

3. Connect the USB Type-C port on the MT37 to your computer with the included USB cable. Then set the USB connection mode to "Charge this device". Then the MT37 will output the scanned data to the PC.

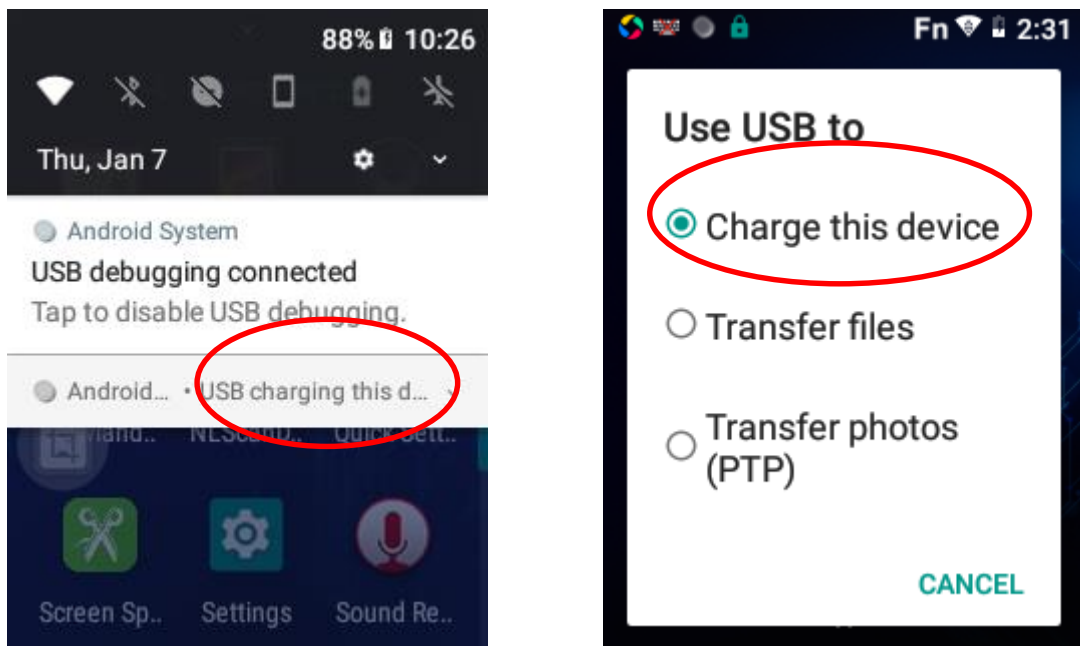

**\*\*Wi-Fi HID Output \*\***

No matter whether the PC is connected to the network by wire or wireless, it must ensure the PC and MT37 are in the same LAN network so that the Wi-Fi HID function can be work.

1. Use the MT37 device to scan the below QR code, then the output mode of the MT37 will switch to “Output via API”.



2. Set the parameters of “Wireless Scan Configure Tool” on the PC as below. If the App is blocked by the firewall/anti-virus software, please add the App to the firewall/anti-virus exceptions.

- 1) Tap the “Wireless Scan Configure Tool” and set the IP, Wi-Fi SSID, Wi-Fi Password.

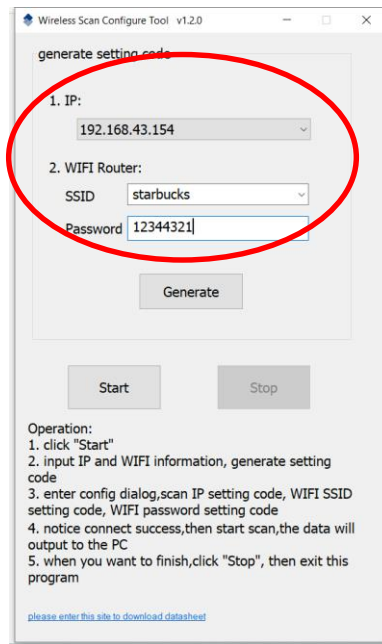



- 
- 2) Tap the "Generate" key on the tool, then it will pop up three setting codes (the "IP setting code", "Wi-Fi SSID setting code", and "Wi-Fi password setting code") on the PC screen.

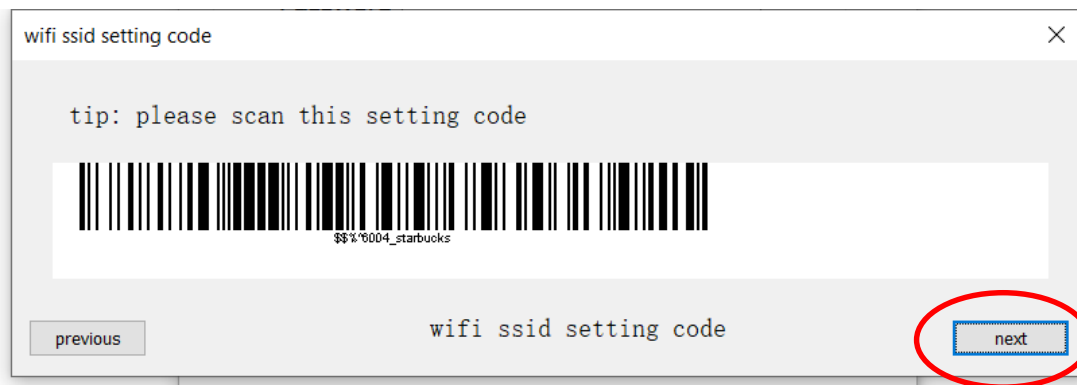

3. On the MT37, tap the quick setting icon  -> "Output Settings" -> "Wi-Fi Output Setting" -> Set the IP, Wi-Fi SSID, Wi-Fi Password. You can use the MT37 to scan the above three setting codes generated on the PC to automatically fill in the parameters, or chose to manually input the parameters per your needs.

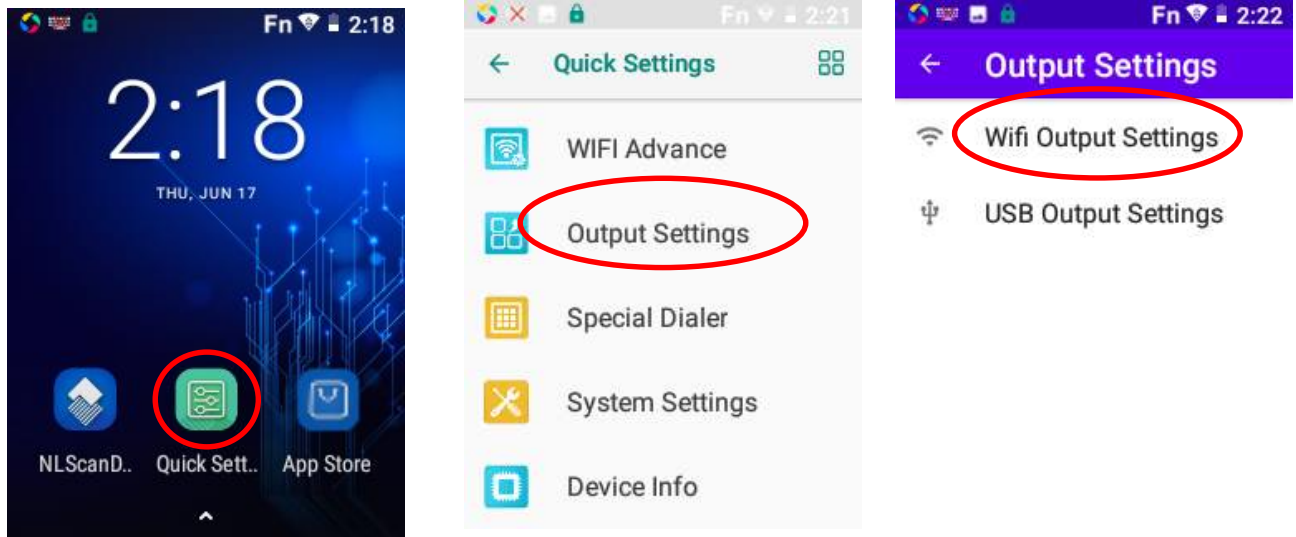

When on the below screen, use the MT37 to scan the three setting codes generated on the PC to automatically fill in the parameters.



4. After finishing the above settings, the MT37 will output the scanned data to the PC.

---

## Shortcuts to Apps

**Create a shortcut to an app on your Home screen:** Tap  on the Home screen. Tap and hold your desired app and then drag it into the home screen.

## Widgets

**View all widgets:** Tap and hold the Home screen and then tap .



**Open a widget:** Tap it.

**Add a widget icon to the Home screen:** Tap and hold the Home screen and then tap . Tap and hold your desired widget and then drag it into the home screen.

# Chapter 4 Scanning Barcodes

## Introduction

This chapter includes scanning tips and instructions for setting up the scanner.

## Scanning 1D/2D Barcode

Adjust the scan angle and the distance between the MT37 and the target barcode to make them fall into the following ranges:

1. Point the MT37's focus lamp at the center of the barcode.
2. Move the MT37 until you find the appropriate scan distance.
3. Optimum scan angles:

Skew ( $\alpha$ ) < 45° (0° preferably)

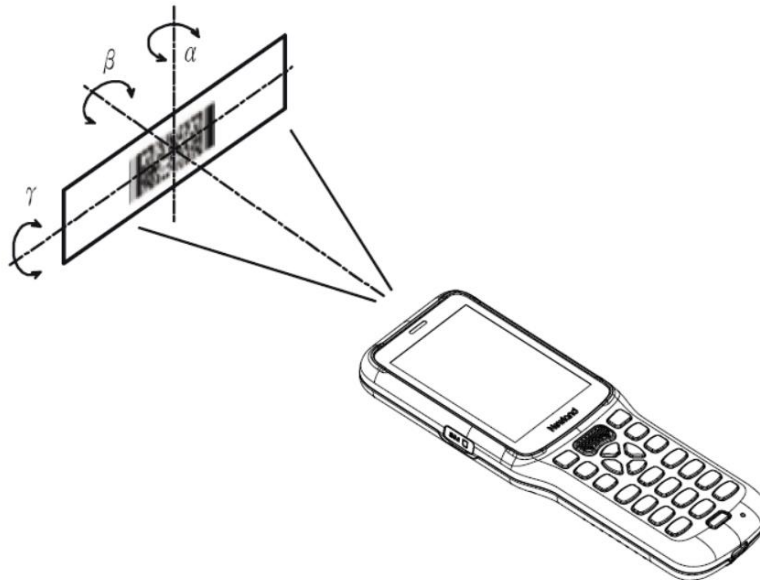

Pitch ( $\gamma$ ) < 45° (5° - 20° preferably)

Roll ( $\beta$ ) = 0° - 360°



---

## Programming Scanner

Tap the quick setting app icon  on the home screen-> tap the scan app icon  to set the scanner parameters as per your actual needs.

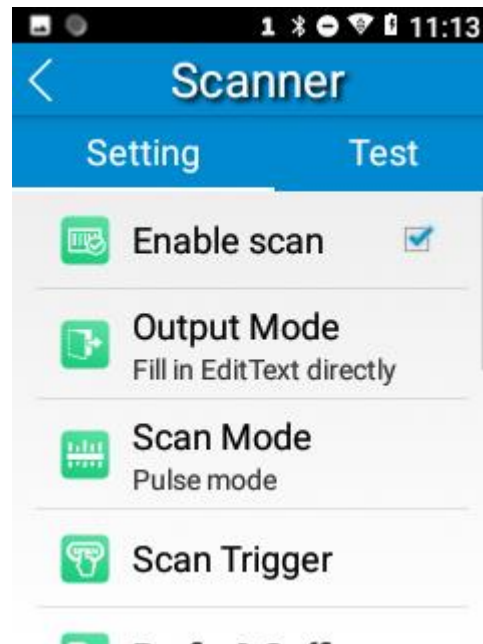
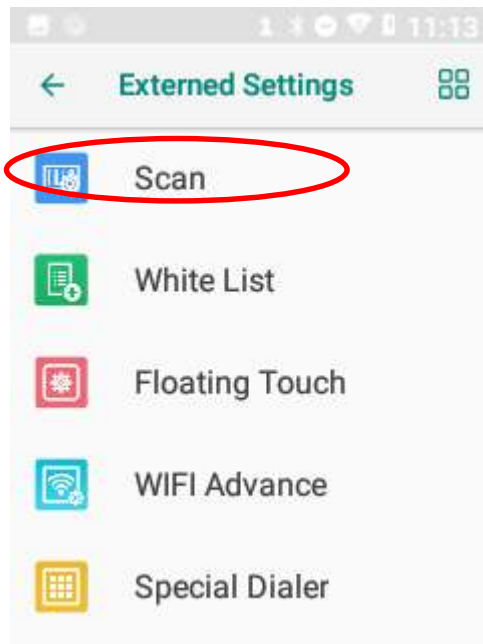

---

## Enable scan

Check or uncheck the “Enable scan” item to enable or disable the scanning feature of the MT37.

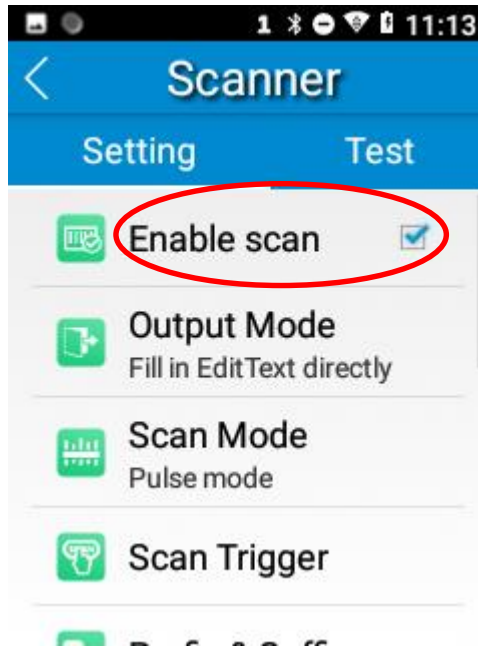

---

## Output Mode

The MT37 provides three output modes: Simulate keystroke, Output via API, and Fill in EditText directly.

1. **Simulate keystroke:** Output scanned data to keyboard buffer to simulate keyboard input. Character interval (ms): A character interval of 0-100 milliseconds may be placed between the transmission of each character of scanned data.

2. **Output via API:** Application acquires scanned data by receiving system broadcasts.

3. **Fill in EditText directly:** Output scanned data at the current cursor position in EditText.

**Overwrite output:** Clear the text input box before sending the barcode currently scanned to make sure only the most recently scanned data is present in the text input box. This feature is available only when Simulate keystroke or Fill in EditText directly is selected.

**Output enter-event:** Send an Enter Key after each barcode is scanned.

**Send virtual keyboard function:** Make send virtual keyboard function as “action done”, “action search”, “action previous”, action search, etc.

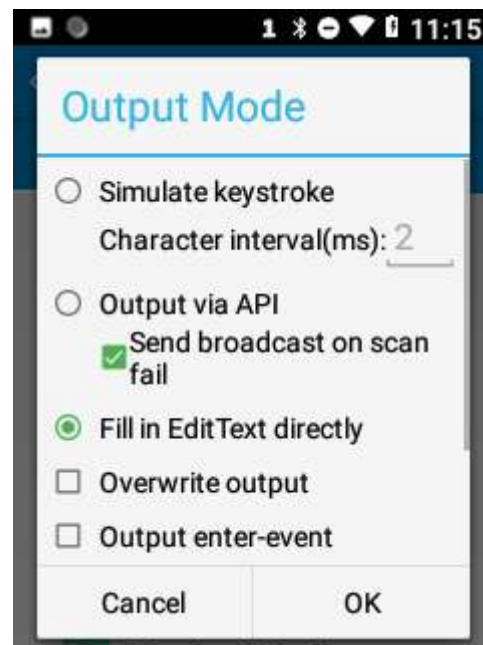
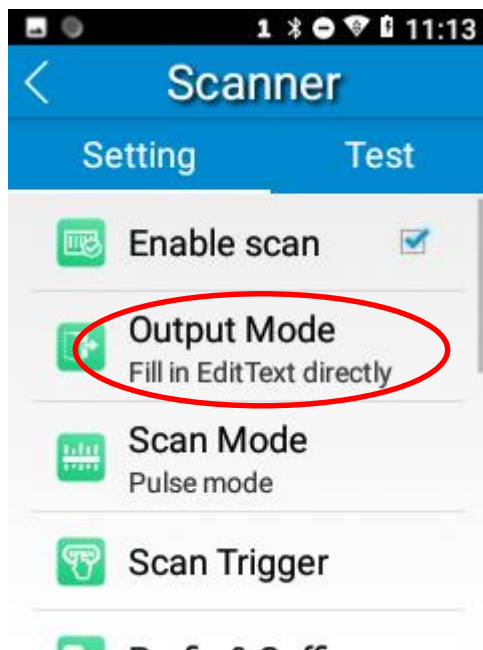

---

## Scan Mode

The MT37 provides four scan modes: Level mode, Continuous mode, Pulse mode, and Delay mode.

1. **Level mode:** Press the scan trigger to start a decode session which continues until the trigger is released.
2. **Continuous mode:** Press the scan trigger to continuously read barcodes. To suspend or resume scan operation, simply press the scan trigger.

**Scan interval (ms):** This parameter sets the timeout between decode sessions.

3. **Pulse mode:** Press the scan trigger to start a decode session which continues until the decode session timeout expires.
4. **Delay mode (Scan on release key):** Press and hold the scan trigger to aim at barcode then release it to start a decode session which continues until the decode session timeout expires or a barcode is decoded. It is advised to use this scan mode and the Central Area Decoding feature to ensure that only the desired barcodes are read if multiple barcodes are placed closely together.

**Decode session timeout (ms):** This parameter sets the maximum time decode session continues during a scan attempt. To set it, enter a desired value and then tap "OK".

**Masked repeat interval (ms):** This parameter sets the time period before the scanner can read the same barcode a second time.

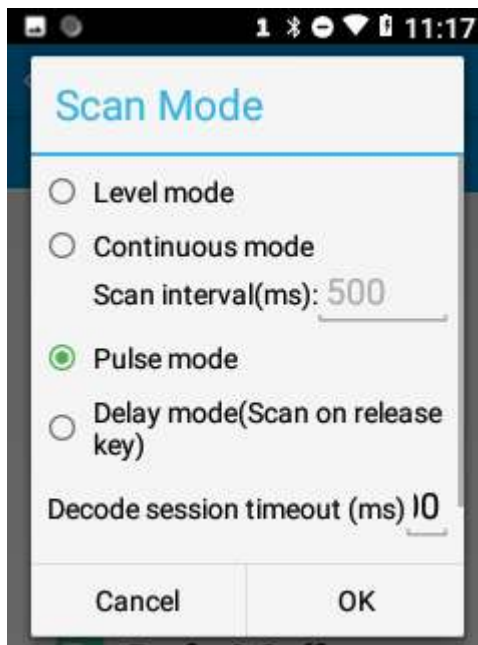
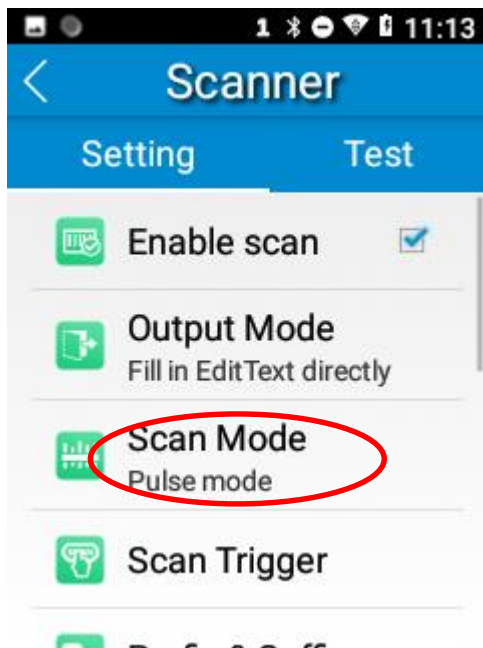



---

## Scan Trigger

The scan key on the terminal can all serve as scan trigger. Enable or disable it as per your actual needs.

**SCAN key:** Use the Scan key on the front panel of the terminal as scan trigger.

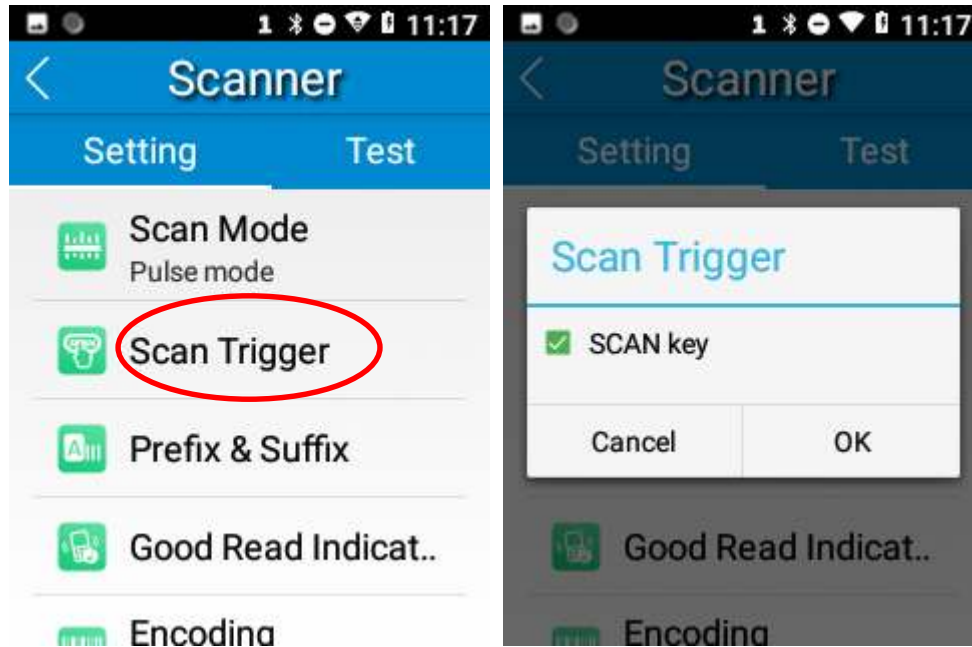

---

## Prefix & Suffix

To set the prefix/suffix, enter the hexadecimal value of a desired prefix/suffix and then tap “OK”. For example, if you want to add a Line Feed character after each barcode, set the suffix to “0A”; if you want to add a Carriage Return character after each barcode, set the suffix to “0D”.

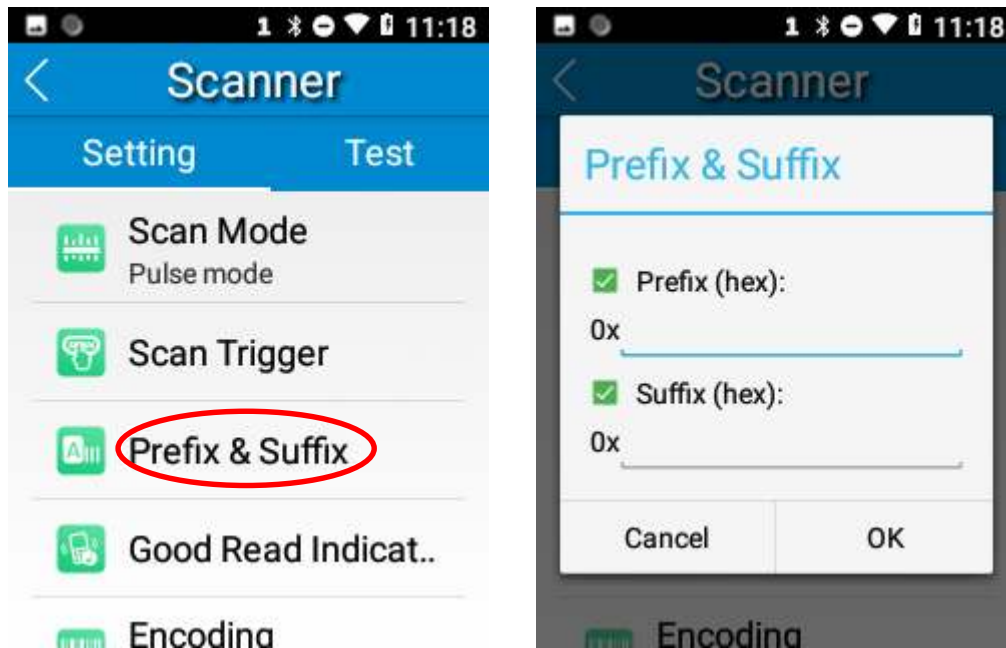

---

## Good Read Indicator

The terminal can use sound/ vibration/ LED to indicate a good read. Choose one or more options as per your actual needs

1. **Sound:** The MT37 issues a short beep to indicate a good read.
2. **Vibrating:** The MT37 vibrates to indicate a good read.
3. **LED:** The blue LED on the MT37 flashes once to indicate a good read.

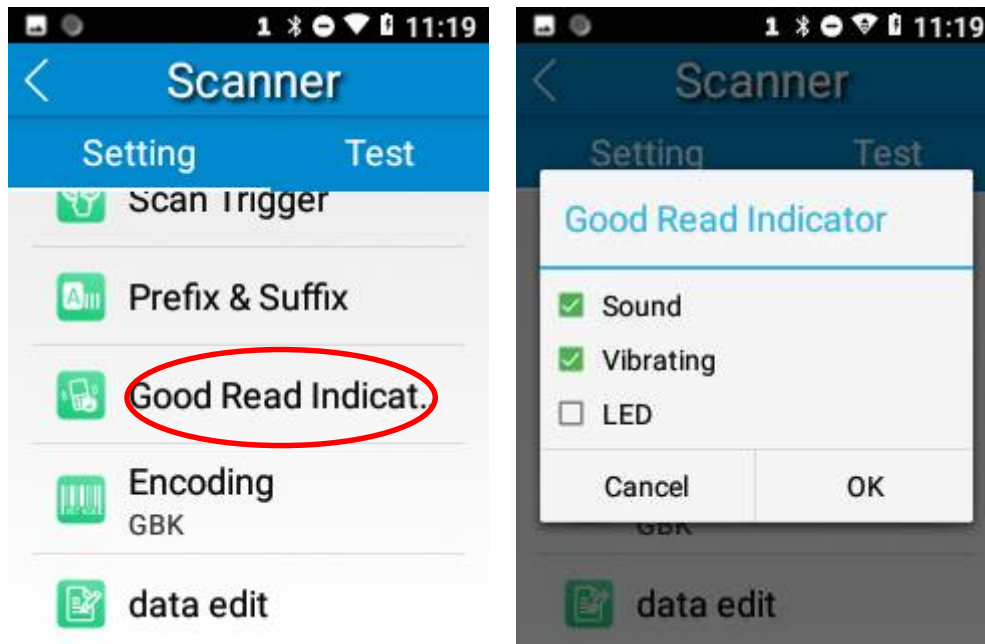

---

## Encoding

Choose a character encoding to interpret barcode data.

1. **AUTO**: The terminal determines automatically if the target barcode uses UTF-8, GBK, ISO-8859-1, and windows-1251 encoding. If the terminal produces wrong output, you may need to choose or enter a specific character encoding.
2. **UTF-8**: Dominant Unicode encoding.
3. **GBK**: A character encoding for Chinese characters.
4. **ISO-8859-1**: A common character encoding that covers Western European languages.
5. **windows-1251**: A character encoding designed to cover language that uses the Cyrillic alphabet such as Russian, Bulgarian, Serbian Cyrillic, and other languages.
6. **Other**: Enter a different character encoding when UTF-8, GBK, ISO-8859-1, and windows-1251 are not applicable. If the terminal does not support the encoding entered, this setting will fail.

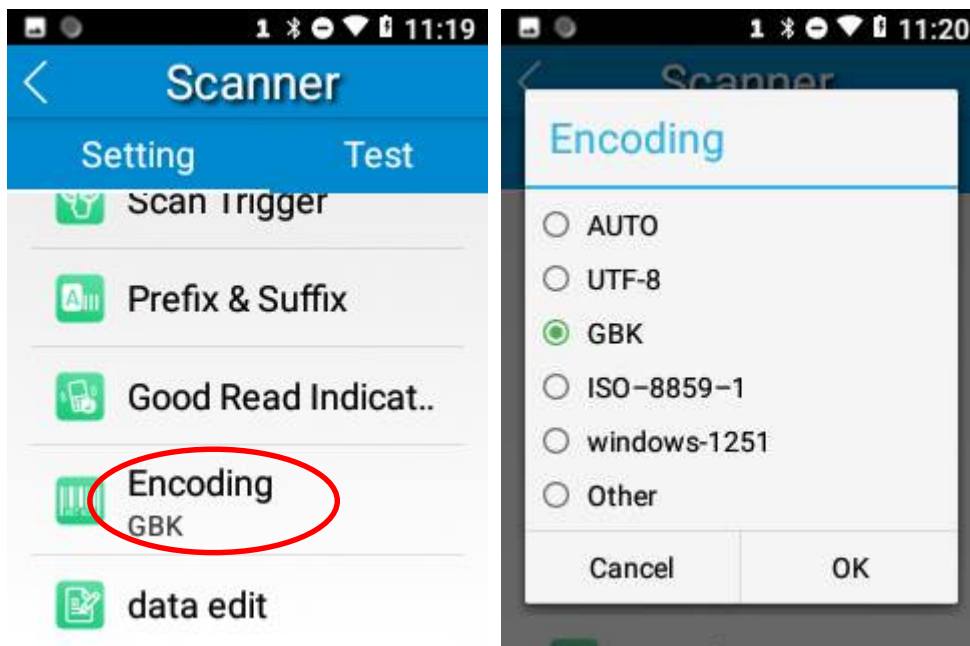

---

## Data Edit

This feature allows you to edit barcode data with a script. Tap “load script” and then select the desired script file on the terminal, or scan the 2D barcode that contains a script, to load the script. Then select “exec script” and tap “OK”.

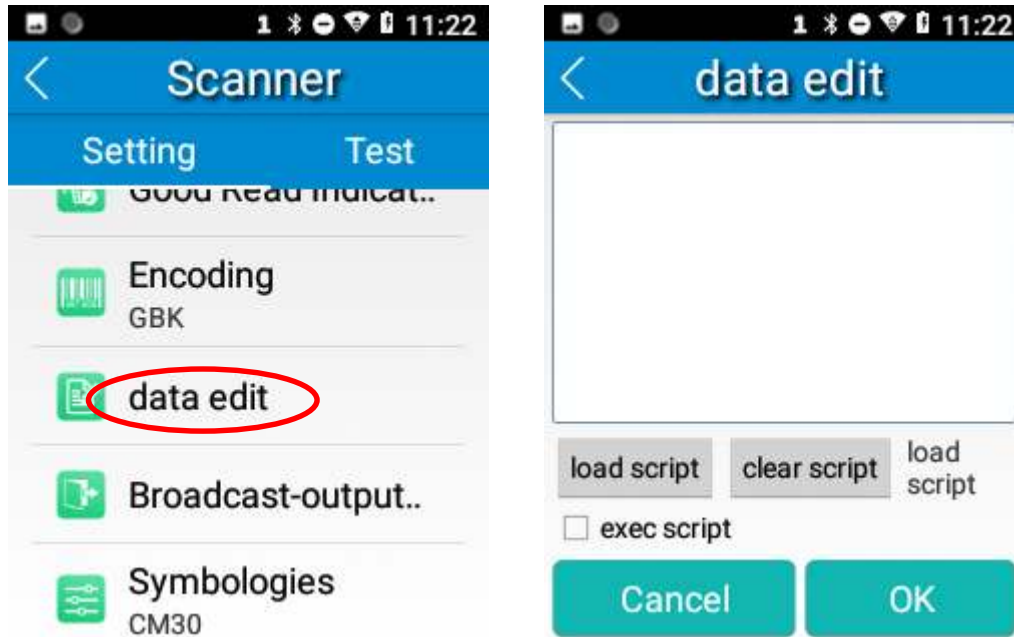

---

## Broadcast-output settings

When using broadcast as the scan output method, the MT37 will output the scan information with the specified broadcast ACTION and EXTRA.

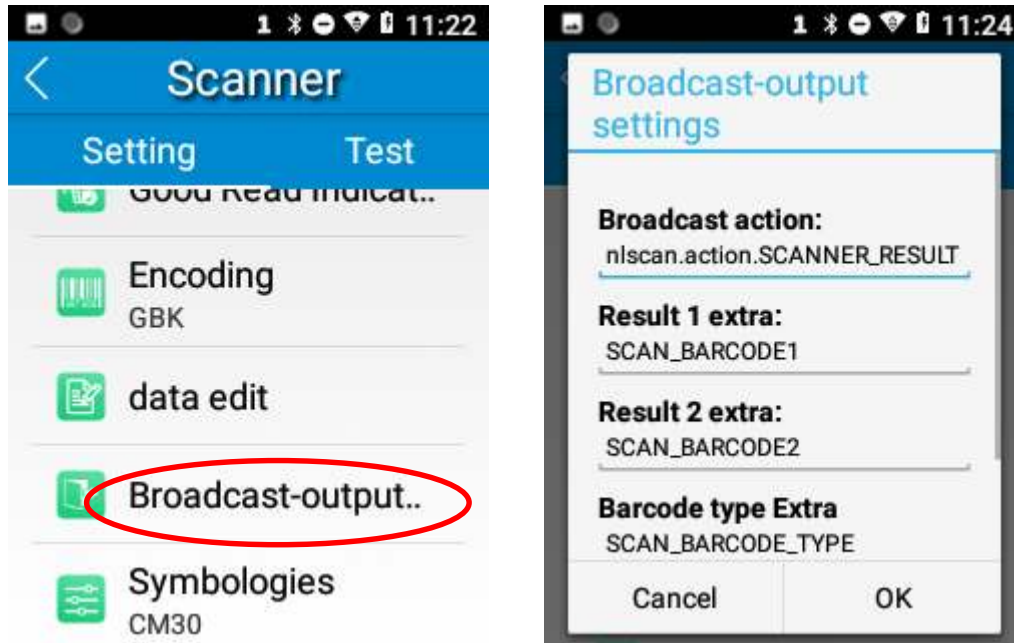

## Symbologies

Note that supported symbologies depend on the scan engine integrated in the terminal. Here we will take CM30 for example.

1D code: Enable or disable 1D symbologies and set other barcode parameters.

Below is remarks for ITF codes:

- 1) The higher the security level, the lower the error rate of ITF code.
- 2) The barcode reading performance at the higher security level is not as smooth as that at low security. Therefore, the default security level is 1. Increase the security level only when the error rate is high.

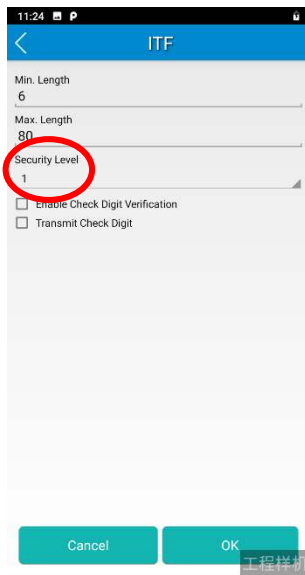

2D code: Enable or disable 2D symbologies and set other barcode parameters.

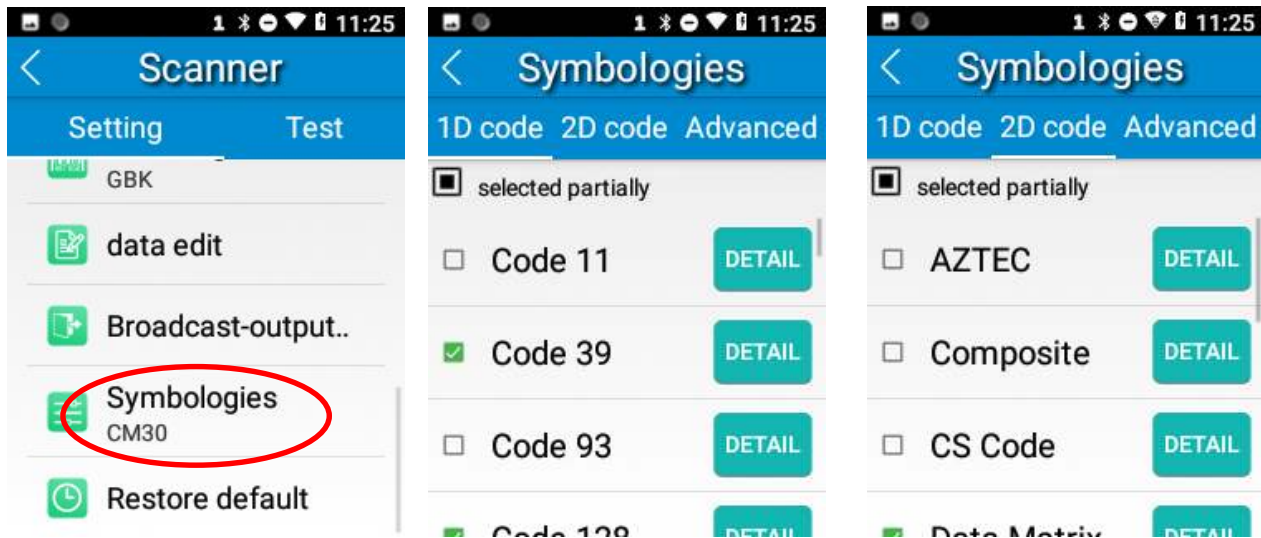

**Advanced:** The features listed here are designed to improve the scanning performance and energy efficiency of the terminal.

1. **Acuscan decoding:** When selected, the terminal only decodes the barcode aimed squarely by the aiming pattern. It is advised to select it to ensure that only the desired barcodes are read if multiple barcodes are placed closely together.

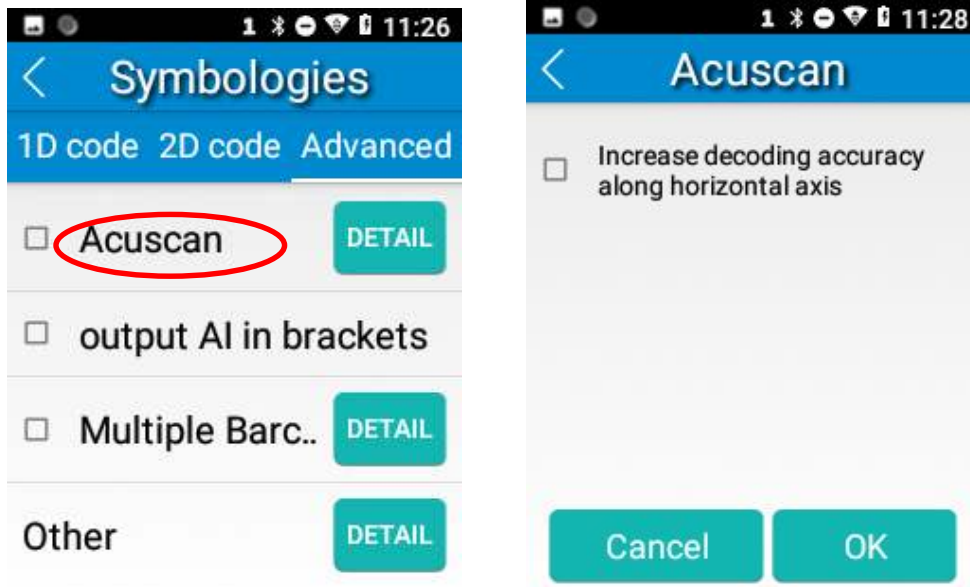

2. Enable output AI in brackets.

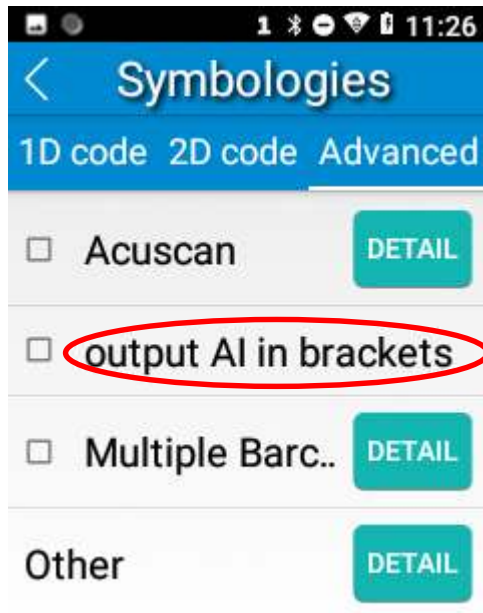

3. Multiple Barcode Scan



You can scan multiple barcodes at a time. You can set the maximum number of scans, then press and hold the scan button to scan once.

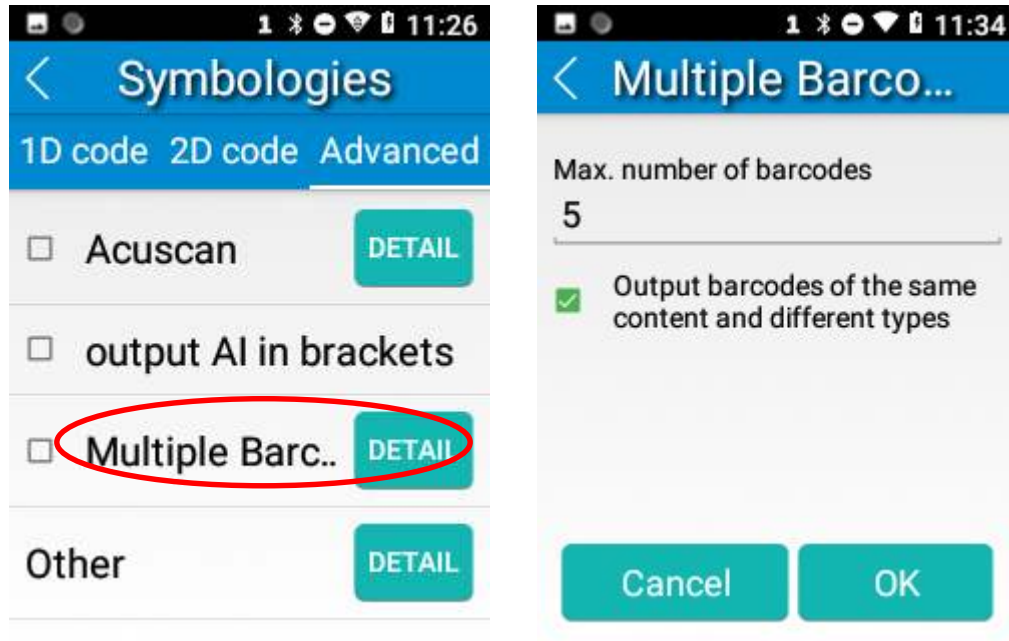

2. **Other:** Tap **DETAIL** to access the following parameter settings.

**Noise reduction:** This feature is designed to reduce noise in images produced by the terminal. However, the terminal shows a slight decrease in scanning speed when using this feature. It is recommended to enable it only when necessary.

**Power plan:** Two options are provided.

**Power saving:** The terminal's built-in scanner turns off automatically after 3 seconds of inactivity.

**High-performance:** The terminal's built-in scanner turns off automatically after 15 seconds of inactivity.

**OCR Enable:** Select this check box when reading passports (compliant with ICAODoc9303 standards, TD1/TD2/TD3 supported).

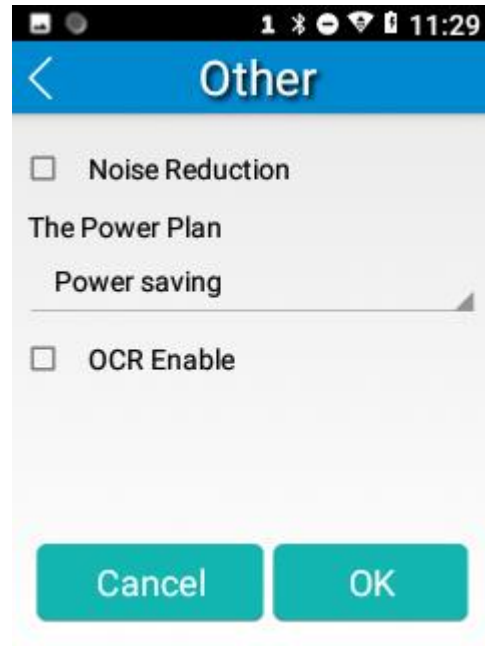
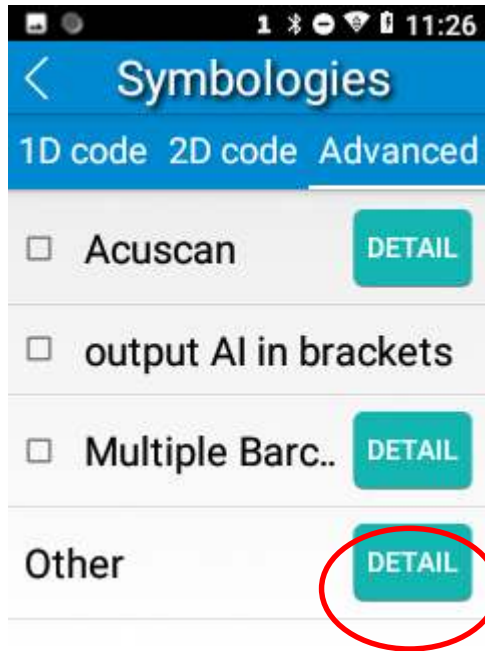

## Chapter 5 Bluetooth

This chapter describes how to connect the MT37 to other Bluetooth device.

You can set up a Bluetooth connection between the MT37 and other Bluetooth devices, such as PC, mobile phone. Note that Bluetooth connection works better if there are no obstacles between them.

Before you can use a Bluetooth device with the MT37, you must first pair them.

1. Make the Bluetooth device visible to the MT37.

2. Tap the app icon  -> "Connected devices" -> "Bluetooth", and turn Bluetooth on to search for available Bluetooth devices.

3. Select the device from the search results to pair.

4. If prompted, input the pairing code and then tap "OK"; or if the pairing code is given automatically, then tap "PAIR".

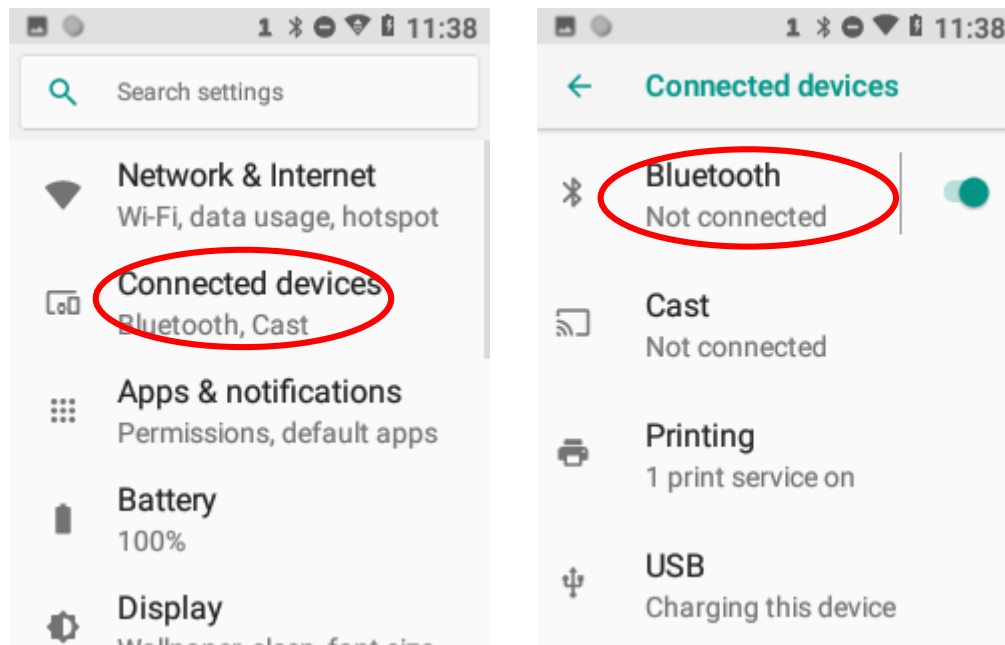

**Unpair/rename a paired Bluetooth device:** Tap the app icon  then "Connected devices" -> "Bluetooth", and turn

Bluetooth on. Tap "paired device". To rename the paired Bluetooth device, tap  and edit its name manually and then tap "OK". To unpair it, tap "FORGET".

# Chapter 6 Wi-Fi

## Introduction

This chapter describes how to connect the MT37 to a Wi-Fi network.

## Wi-Fi Settings

### Join a Wi-Fi network:



1. Tap the app icon  -> "Network & Internet"-> "Wi-Fi", and turn Wi-Fi on to find available Wi-Fi networks. If Wi-Fi is already ON, then the terminal will automatically scan for available networks.
2. Tap a network and then enter the password.
3. Tap "CONNECT".

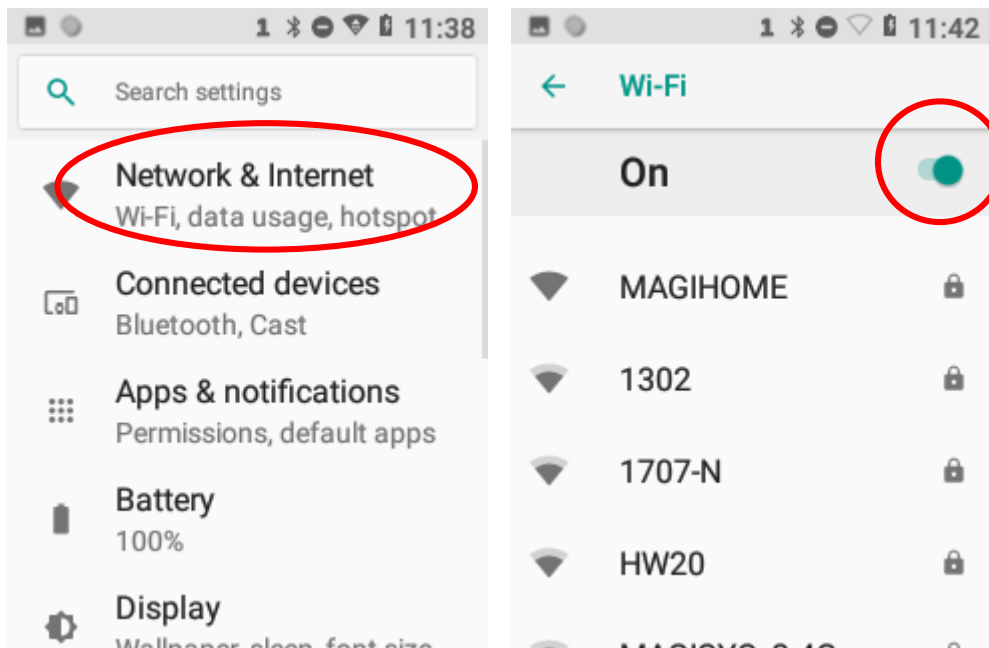

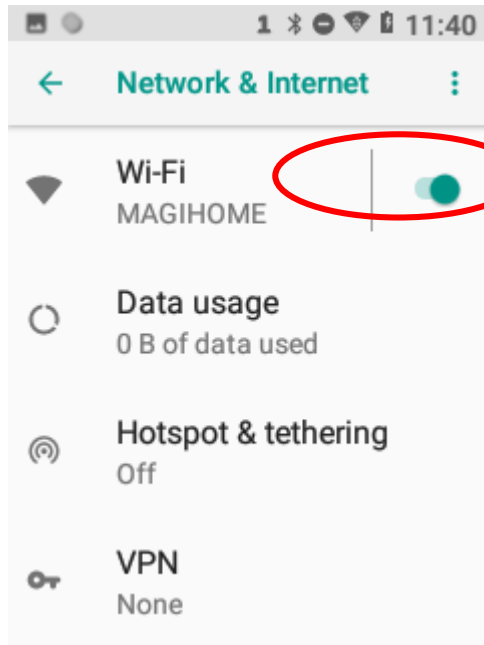
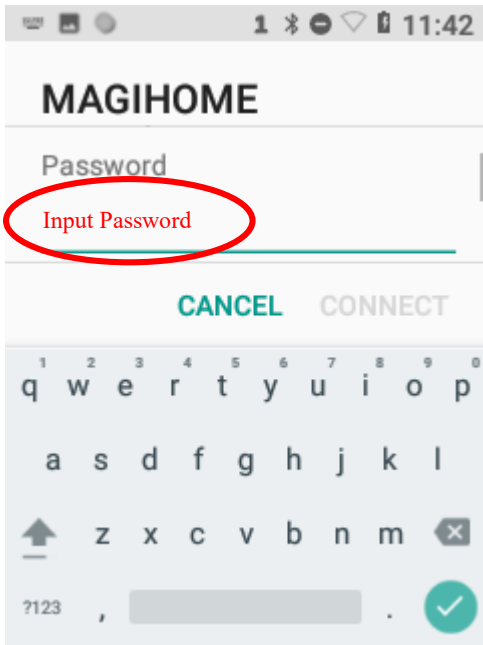

## IP Settings

To set the IP, follow the first two steps of joining a Wi-Fi network, check the “Advanced options” item, tap “DHCP” and choose your desired option.

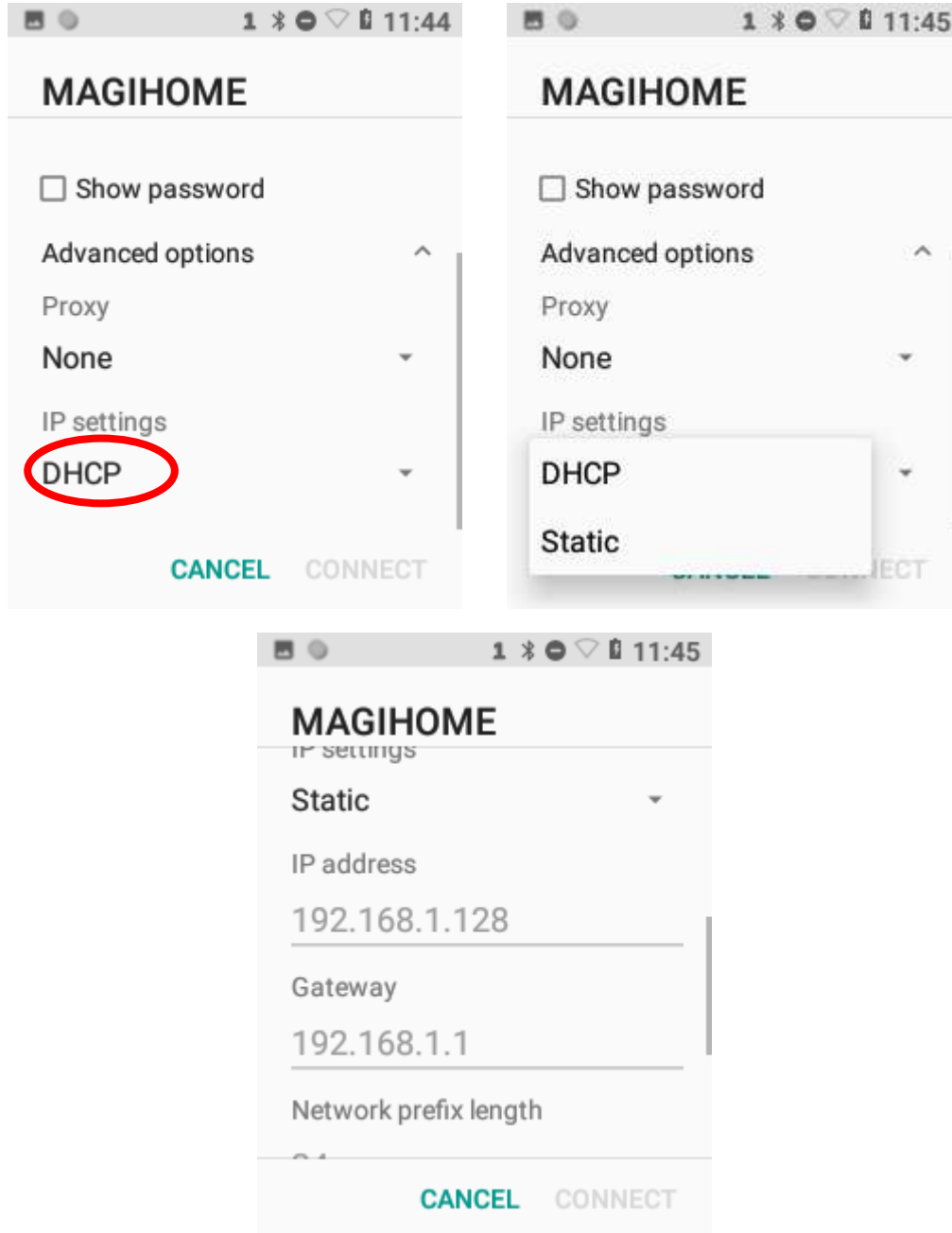

## Chapter 7 Mobile Network (Only for 4G Version)

### Introduction

The MT37 can also use 4G network to connect to the internet. To establish 4G connection, you must have a Micro SIM card installed in your MT37.

### Mobile Network Settings

If no Wi-Fi networks are available, or if you've turned Wi-Fi off, then the MT37 connects to the Internet via your cellular data network when available.

Turn on cellular network: Tap  and then turn Cellular data on.

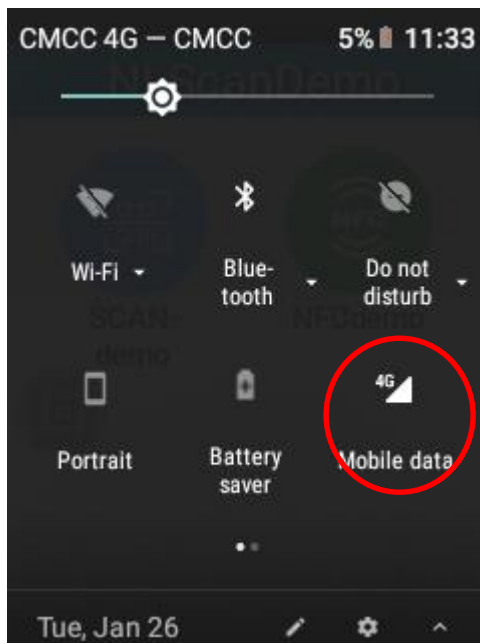



---

## APN Settings

If you cannot connect to the internet when using your terminal's cellular data, you may need to change your APN settings on the MT37 to fix it:

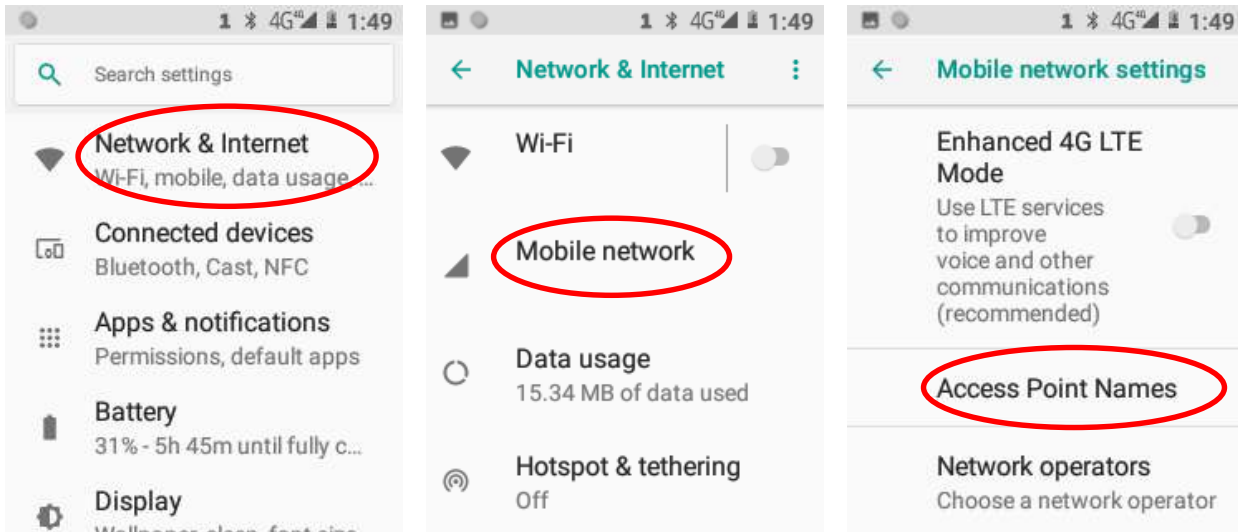
1. Go to Settings -> Network & Internet -> Mobile network -> Access Point Names.



2. Tap  in the top right corner of the screen or tap the carrier of your SIM card on the screen. Then manually enter the APN settings. You can contact your carrier or visit their website to get the correct APN settings, or check the APN settings on a mobile device that can access the internet using the SIM card.

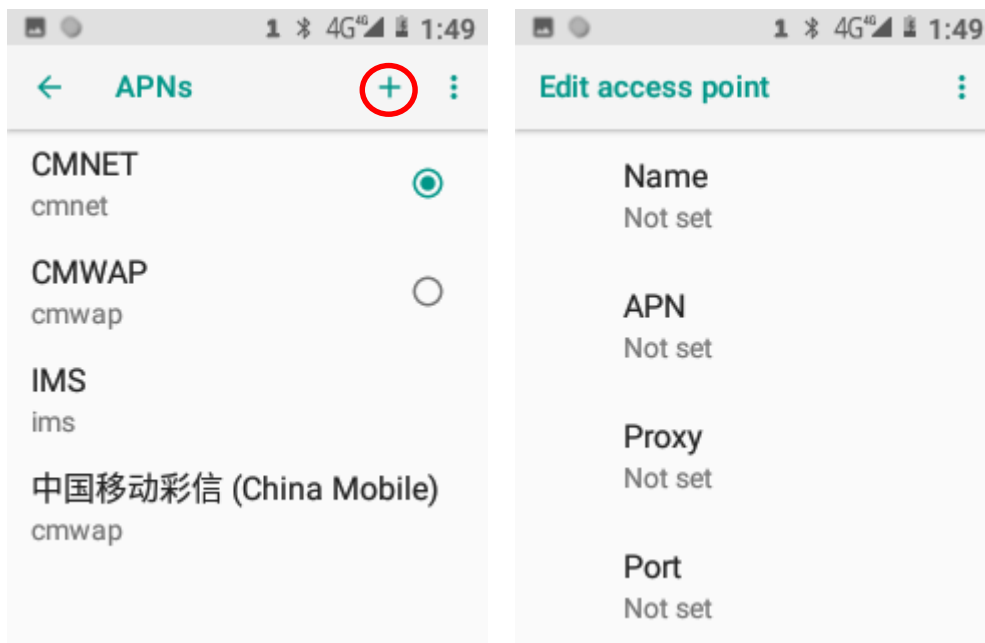

3. Press the Return key on the MT37 to go back to the previous screen and then select the APN you just added.





# Chapter 8 Admin Tool

## Introduction

The Admin Tool app is used to specify the apps that users can run on the MT37.

## Admin Mode Setting

Tap  on the Home screen then  to launch the admin tool and enter the Admin mode. Enter the password (default: 112233).

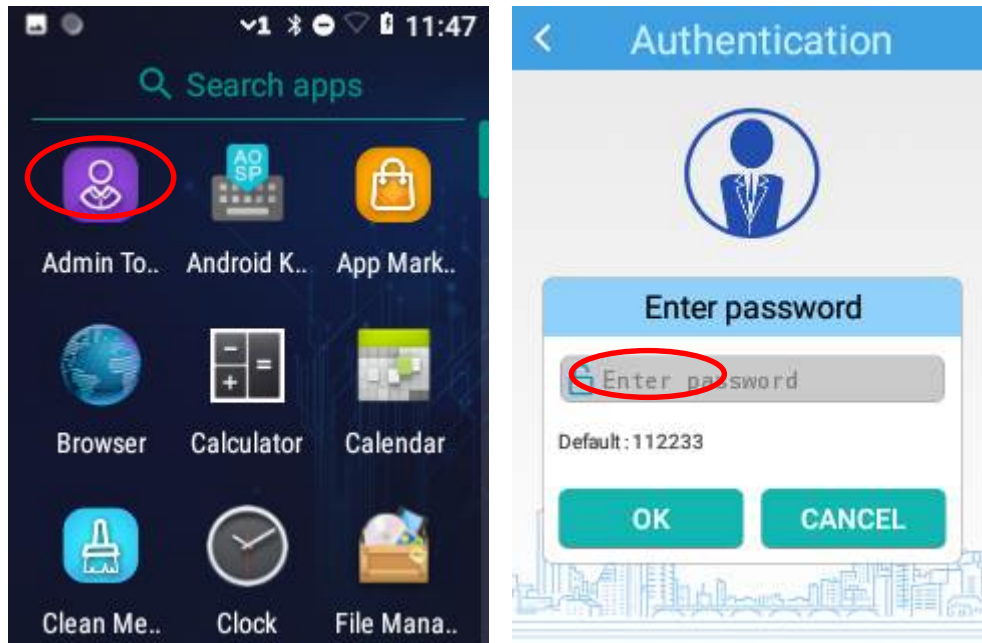

---

When in the Admin mode, you may set the following parameters as per your actual needs.

1. App manager: Tap "App Manager" -> "Select App", then select or deselect the apps available to normal users.

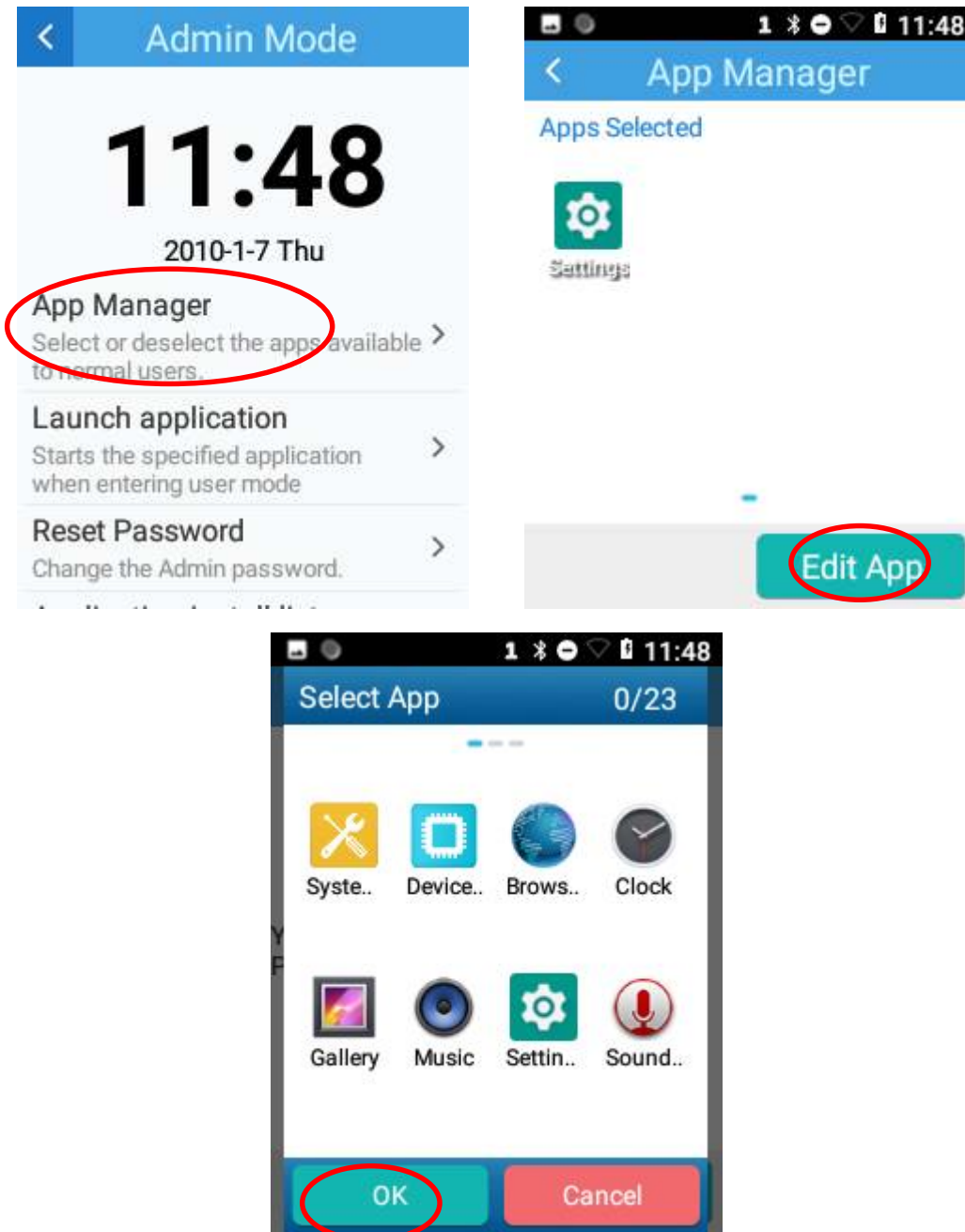

2. Launch application: Starts the specified application when entering user mode. Please note that only one app can be set.

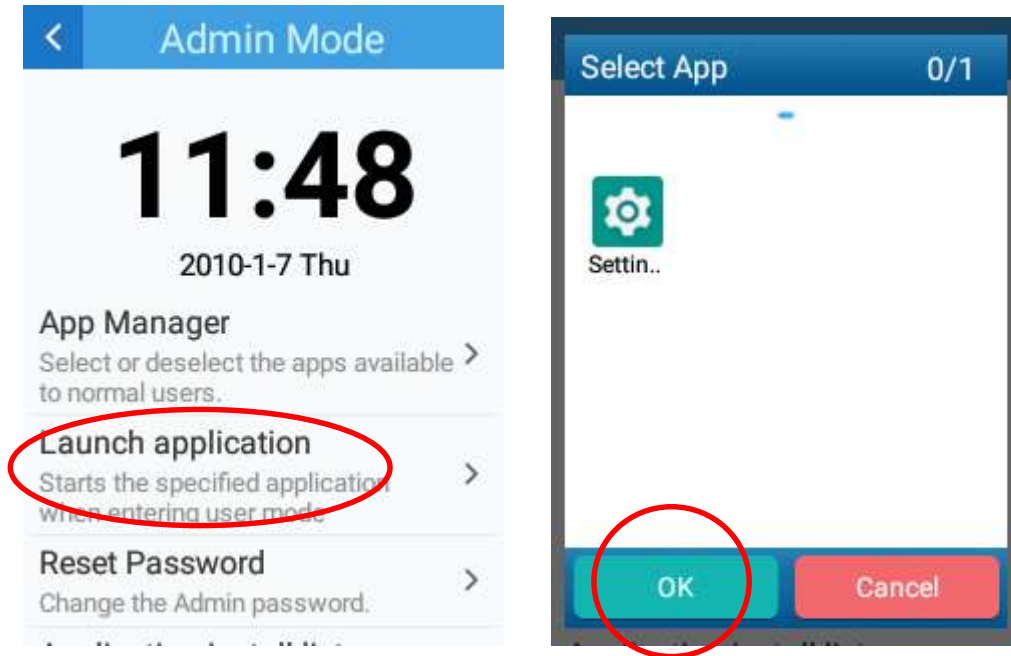

3. Reset password: Change the Admin password.

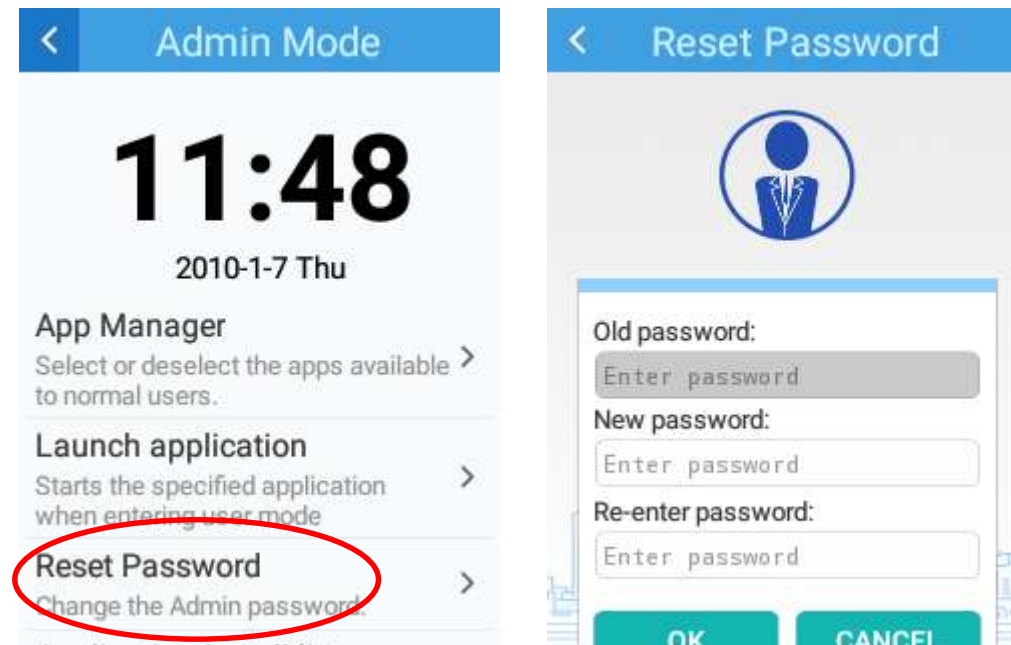

---

4. Application install listener: Add new application to list in user mode.

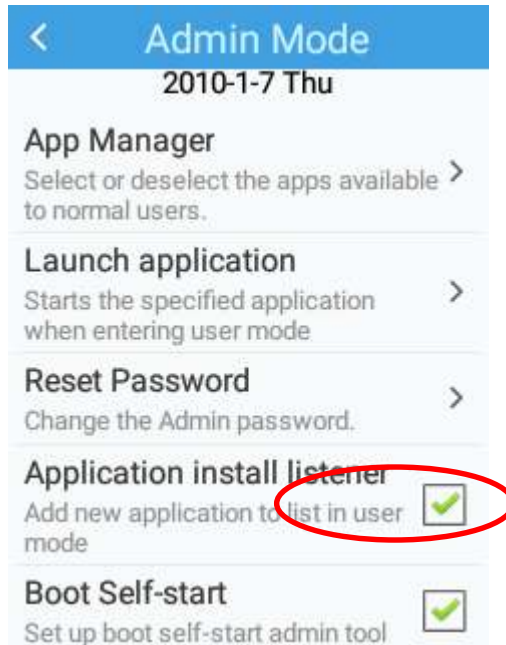

5. Boot self-start: Set up boot self-start admin tool.



---

6. Exit: Exit admin tool.

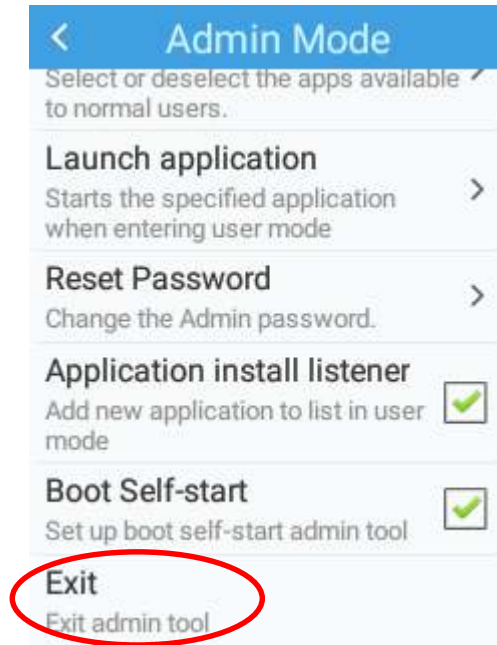



# Chapter 9 Whitelist Manager

## Introduction

The Whitelist Manager app is used to specify the apps that users can install on the MT37.

## Logging in to Whitelist Manager

Tap  "Quick Setting" on the Home screen then , enter the password (default: 112233), and tap "Login" to log in to the whitelist manager. Then set up your Whitelist as per actual needs.

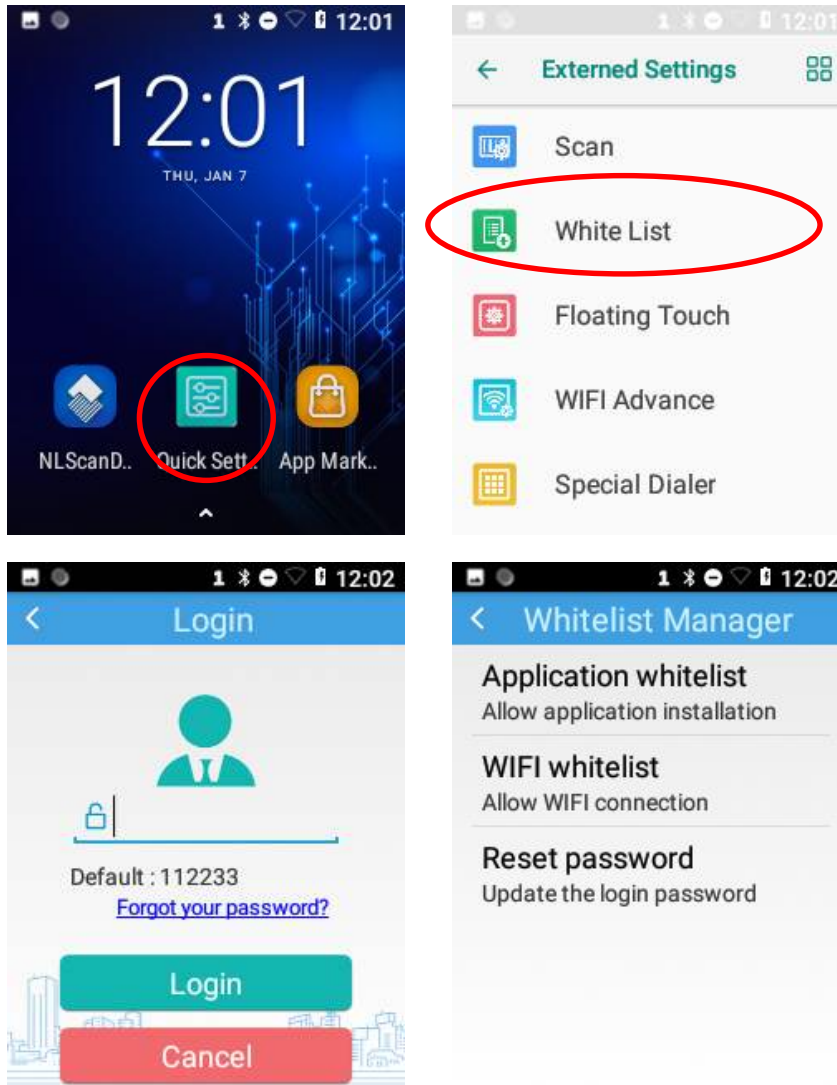

## Chapter 10 Others

### GPS



Tap the app icon  then “Security & Location”, and then:

1. Turn Location on.
2. Tap “Mode” and then choose a location mode as per actual need.
3. Use a third-party map app or other GPS apps to obtain location information.

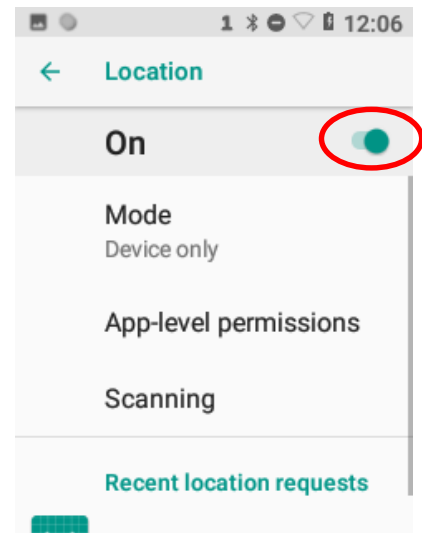
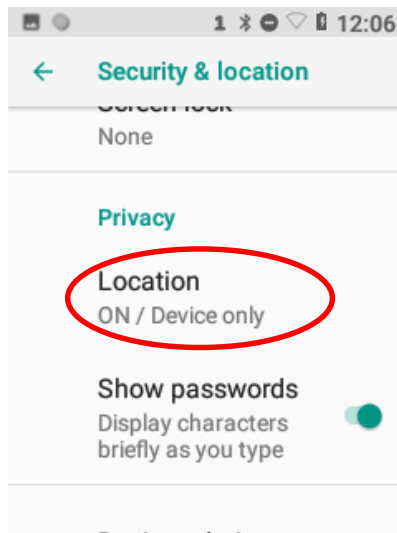
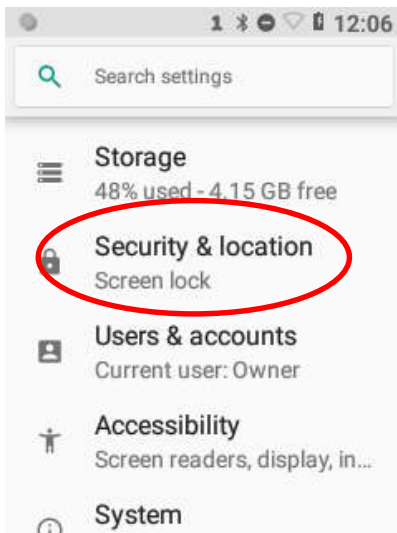

---

## NFC (optional)



To enable the NFC feature, tap the app icon  -> “Connected devices” -> “NFC”, and then turn on NFC. Then you can install an NFC writer on the MT37 to read and write NFC tags.

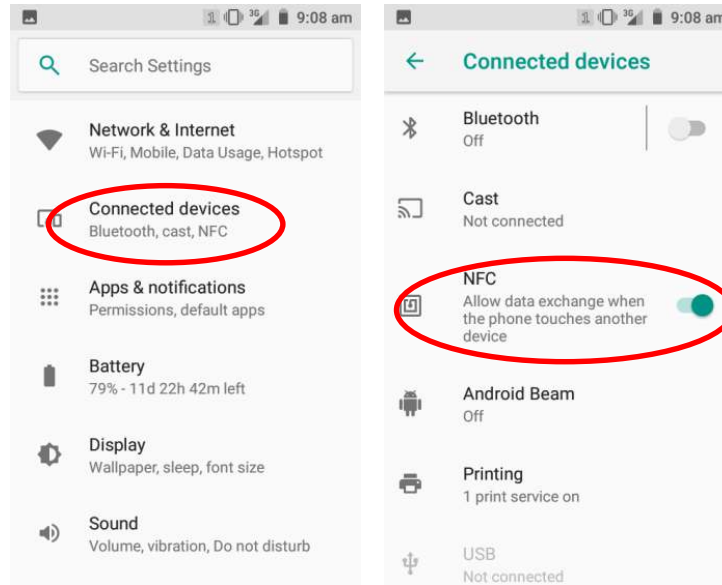



---

## Memory Cleanup

Press and the Home key on the MT37, and enter app list until the terminal displays the following screen and then tap



to clean up the memory.

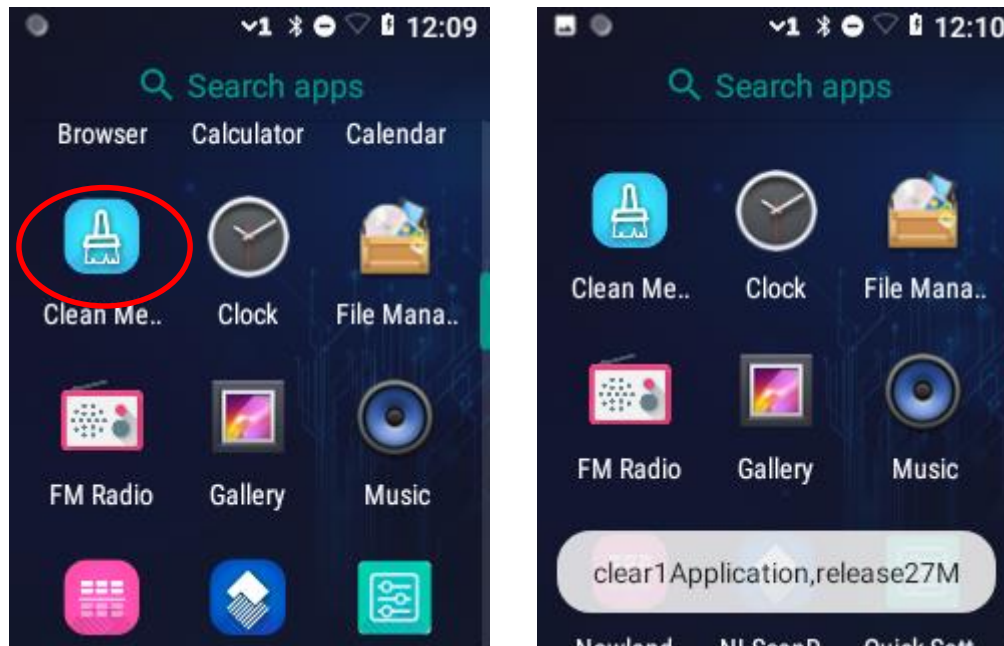

**Note:** When your terminal becomes less efficient after having run for extended periods of time, you may perform a memory cleanup or reboot the terminal to fix the problem.

# Chapter 11 System Update

## Introduction

This chapter introduces two methods to update the system software of the terminal: Online update and local update.

## Online Update

Update the system online: Tap  on the Home screen -> "CHECK FOR UPDATES".



## Locate Update

### Zip File to the MT37 Drive

1. Connect the terminal to PC with the included USB cable. Swipe from top to bottom with one finger in one smooth motion to open the notification bar. Tap "USB for file transfer". Then select "Transfer files".

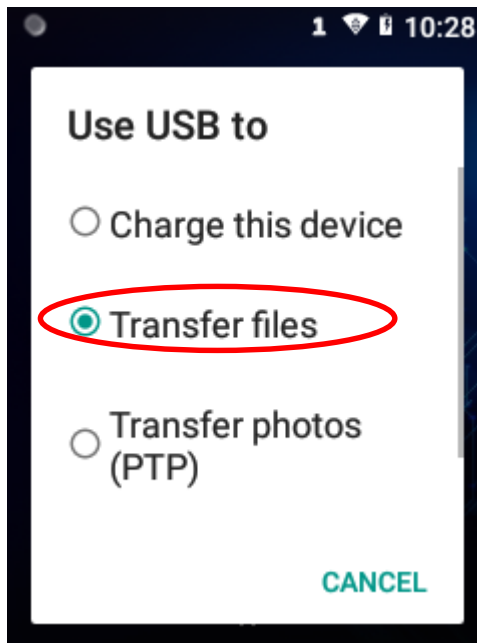

2. Copy the update zip file to the MT37 drive.

 MT30-C Factory V1.00.004.zip

3. Tap  on the MT37's Home screen then  to access the System Update screen.



4. Tap  in the top right corner of the System Update screen, and then select “Local Update”.

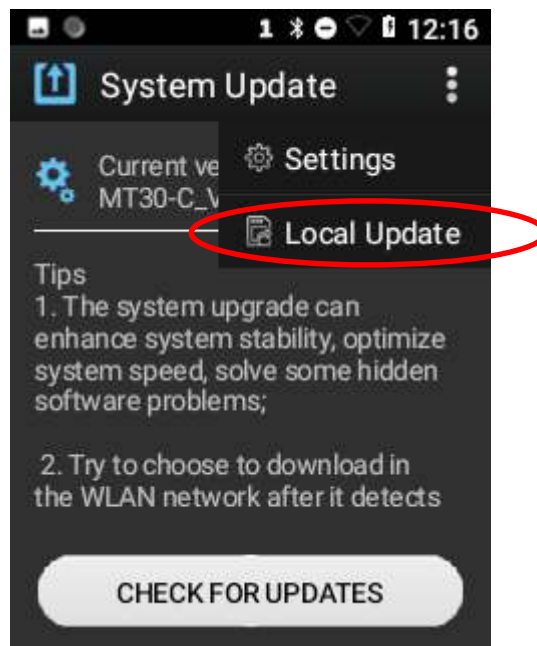

5. Select the update zip file. Then select “NEXTREBOOT” or “UPDATE”.

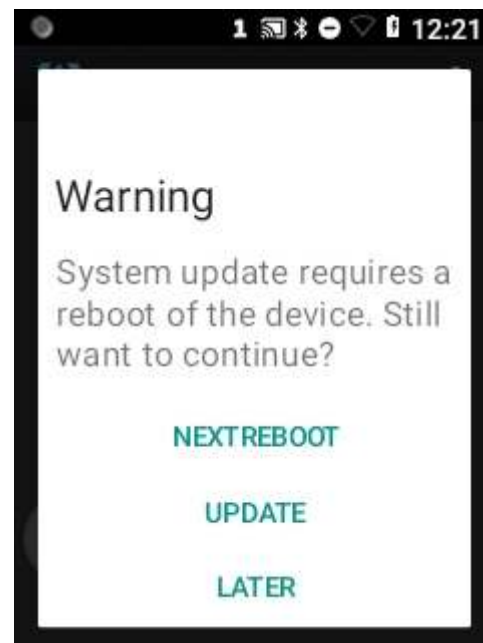
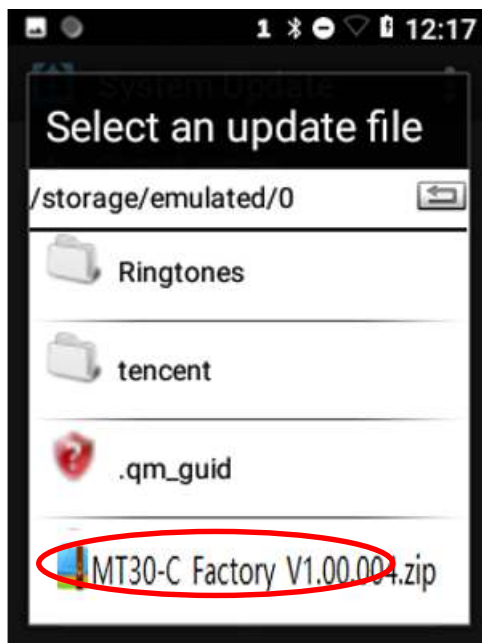

## Chapter 12 App Development Guide

### Development Environment

The MT37 runs on the Android 8.1 operating system, so you should use Android SDK 8.1 or lower when developing apps for the MT37.

### Use of Non-standard Interfaces

See **Newland Android PDA API Handbook**.

# Chapter 13 Maintenance & Troubleshooting

## Introduction

This chapter includes important safety and handling information and provides troubleshooting solutions for issues that might occur when using the terminal.

## Important Safety & Handling Information

### Disassembly and Retrofit

Do not disassemble or retrofit the terminal by yourself. Unauthorized disassembly or retrofit will void the warranty.

### External Power Supply

Use only the AC adapter that meets the USB charging specification (recommend 5V,2A ). Otherwise, there is a risk of damage to the terminal.

### Abnormal Situation

Keep the terminal away from fire or heat sources. If there is unusual odor, overheating or smoke during charging, immediately cut off the power and disconnect the AC adapter, and contact your dealer or Newland customer service center. Continued use in this case may result in fire or electric shock.

### Drop Damage

If the terminal is damaged due to a drop from high place, immediately power off and contact your dealer or Newland customer service center.

### LCD Screen

Do not press against or strike the LCD screen. Otherwise, it may damage the screen. When handling a cracked or shattered screen, do not touch the liquid that has leaked from it to avoid skin burn or infection.

### Stacking Heavy Objects

Do not place heavy objects on the terminal as those objects may fall and cause injury.

### Mounting Location

Do not place the terminal on unstable or uneven surfaces as it may fall and cause injury. Do not expose the terminal to humidity or dust as this may cause fire or electric shock. Do not expose the terminal to direct sunlight for extended periods.

---

## Wireless Functionalities

Do not use the terminal's wireless functionalities where wireless device use is prohibited or where it may cause interference or danger, such as in aircrafts, petrol stations.

## Use & Maintenance

- ✧ If the terminal cannot be switched on after experiencing a sudden or unexpected power loss or other abnormalities, please long press the power key for 30 seconds to force reboot the terminal.
- ✧ Do not throw, drop or strike the terminal. Doing so may damage the LCD display, interrupt running programs, cause data loss in memory and result in malfunction.
- ✧ Clean the scan window regularly. Do not touch it with hands. Scratched or smudged window may degrade reading performance.
- ✧ Do not tap the touch screen with sharp objects. Doing so may damage the screen or cause internal short circuits.
- ✧ Use only a dry soft cloth to clean the terminal. Cleaning it with wet cloth or benzene/thinner/other volatile chemicals may deform and shorten the service life of the keypad and shell of the terminal.
- ✧ Do not place the terminal facedown on any surface, or there might be misoperations.
- ✧ Sudden temperature drops may cause condensation on the shell which could cause malfunction. Care should be taken to avoid condensation. If condensation occurs, dry the terminal before use.

## Battery Safety Guidelines

- ✧ **Do not dispose of batteries in a fire as they may explode.**
- ✧ The battery can be charged and discharged over 300 times. If the battery life is unreasonably short, please contact your dealer or Newland customer service center to replace the battery with a new one.
- ✧ Use only 5V AC adapter.
- ✧ Do not continue to charge a battery that is fully charged. Overcharging will shorten battery lifespan. If a fully charged battery is not used, it will discharge slowly, which does not affect its normal use.
- ✧ Do not use damaged or faulty AC adapters or batteries.
- ✧ **Properly dispose of and recycle batteries. Do not dispose of them as household garbage.**
- ✧ When the device is not used for a long time, please charge the device to about 60% and store it properly. Charge and discharge once every 6 months for battery maintenance .

## Troubleshooting

Problem		Possible Cause & Solution
Type	Description	
Keypad	Unresponsive keypad or incorrect response to any key entry.	This problem may be caused by unreliable cable connection between keypad and mainboard or keypad malfunction. Please contact Newland after-sales service.
Battery	Charging LED is OFF when charging.	Ensure the AC adapter is plugged in properly.
	Noticeably short battery life.	Check the battery level. If the battery is almost depleted, recharge it.
	Fully charged battery is depleted after the terminal is switched on.	Contact your dealer or Newland customer service center to replace the battery with a new one
USB	USB communication failure	<ol style="list-style-type: none"> <li>1. Ensure that the USB cable connections are secure.</li> <li>2. Ensure that there is no contaminant inside the Micro USB port.</li> <li>3. If the problem remains, please contact the after-sales service center.</li> </ol>
LCD Screen	No display	<ol style="list-style-type: none"> <li>1. Ensure the terminal is switched on.</li> <li>2. If the terminal is in sleep mode, press the Power key to wake it up.</li> <li>3. Check the battery level. If the battery is depleted, recharge it.</li> <li>4. Ensure that the battery is properly installed.</li> <li>5. Replace the battery if it is faulty.</li> <li>6. If the problem remains, please contact the after-sales service center.</li> </ol>
System	Cannot switch on	<ol style="list-style-type: none"> <li>1. Check the battery level. If the battery is depleted, recharge it.</li> <li>2. Switch the terminal on after using the AC adapter to connect it to a power outlet. If the problem disappears, then continue to charge the terminal.</li> </ol>
	System halted	<ol style="list-style-type: none"> <li>1. The problem may be caused by bugs of downloaded apps. Ensure that only reliable apps are used.</li> <li>2. The problem may be caused by a sudden or unexpected power loss. Remove and then reinstall its battery to reset the terminal.</li> </ol>



## **Newland Auto-ID Tech. Co., Ltd. (Headquarter)**

Add: No.1, Rujiang West Rd., Mawei, Fuzhou, Fujian 350001, China  
Tel: +86 (0) 591 8397 9500  
Fax: +86 (0) 591 8397 9216  
E-mail: [info@nlscan.com](mailto:info@nlscan.com)  
Web: [www.newlandaidc.com](http://www.newlandaidc.com)

### **Newland APAC**

#### **Newland Taiwan Inc.**

Add: 7F-6, No. 268, Liancheng Rd., Zhonghe Dist. 235, New Taipei City, Taiwan  
Tel: +886 2 7731 5388  
Fax: +886 2 7731 5389  
Email: [info@newland-id.com.tw](mailto:info@newland-id.com.tw)  
Web: [www.newland-id.com.tw](http://www.newland-id.com.tw)

#### **Newland Japan**

Add: REID-C Meguro Fudomae-Bldg.7F, 3-15-6 Nishigotanda Shinagawa-ku, Tokyo, Japan  
Tel: +81 80 5196 1234  
Email: [info@nlscan.com](mailto:info@nlscan.com)  
Web: [www.newlandaidc.com/jp/](http://www.newlandaidc.com/jp/)

### **Newland Korea**

### **Newland EMEA**

#### **Newland Europe BV**

Add: Rolweg 25, 4104 AV Culemborg, The Netherlands  
Tel: +31 (0) 345 87 00 33  
Fax: +31 (0) 345 87 00 39  
Email: [sales@newland-id.com](mailto:sales@newland-id.com)  
Tech Support: [tech-support@newland-id.com](mailto:tech-support@newland-id.com)  
Web: [www.newland-id.com](http://www.newland-id.com)

### **Newland NALA**

#### **Newland North America Inc.**

Add: 46559 Fremont Blvd., Fremont, CA 94538, USA  
Tel: +1 510 490 3888  
Fax: +1 510 490 3887  
Email: [info@nlscan.com](mailto:info@nlscan.com)  
Web: [www.newlandamerica.com](http://www.newlandamerica.com)

Add: Biz. Center Best-one, Jang-eun Medical Plaza 6F, Bojeong-dong 1261-4, Kihung-gu, Yongin-City, Kyunggi-do, South Korea  
Tel: +82 10 8990 4838  
Fax: +82 70 4369 0009  
Email: [info@nlscan.com](mailto:info@nlscan.com)  
Web: [www.newlandaidc.com/kor/](http://www.newlandaidc.com/kor/)

#### **Newland India**

Add: 814, Tower B, NOIDA ONE business park B-8, Sector 62, Noida, Uttar Pradesh-201301  
Tel: +91 120 7964266  
Email: [info@nlscan.com](mailto:info@nlscan.com)  
Web: [www.newlandaidc.com](http://www.newlandaidc.com)

#### **Newland Latin America**

Tel: +1 (239) 598 0068  
Fax: +1 (239) 280 1238  
Email: [info@newlandla.com](mailto:info@newlandla.com)  
Web: [www.newlandamerica.com](http://www.newlandamerica.com)



**Newland Auto-ID Tech. Co., Ltd.**